

Final Report of the Muon E821 Anomalous Magnetic Moment Measurement at BNL

G.W. Bennett², B. Bousquet¹⁰, H.N. Brown², G. Bunce², R.M. Carey¹, P. Cushman¹⁰,
G.T. Danby², P.T. Debevec⁸, M. Deile¹³, H. Deng¹³, W. Deninger⁸, S.K. Dhawan¹³,
V.P. Druzhinin³, L. Duong¹⁰, E. Efstathiadis¹, F.J.M. Farley¹³, G.V. Fedotovitch³,
S. Giron¹⁰, F.E. Gray⁸, D. Grigoriev³, M. Grosse-Perdekamp¹³, A. Grossmann⁷,
M.F. Hare¹, D.W. Hertzog⁸, X. Huang¹, V.W. Hughes^{13†}, M. Iwasaki¹², K. Jungmann^{6,7},
D. Kawall¹³, M. Kawamura¹², B.I. Khazin³, J. Kindem¹⁰, F. Krienen¹, I. Kronkvist¹⁰,
A. Lam¹, R. Larsen², Y.Y. Lee², I. Logashenko^{1,3}, R. McNabb^{10,8}, W. Meng², J. Mi²,
J.P. Miller¹, Y. Mizumachi¹¹, W.M. Morse², D. Nikas², C.J.G. Onderwater^{8,6}, Y. Orlov⁴,
C.S. Özben^{2,8}, J.M. Paley¹, Q. Peng¹, C.C. Polly⁸, J. Pretz¹³, R. Prigl², G. zu Putlitz⁷,
T. Qian¹⁰, S.I. Redin^{3,13}, O. Rind¹, B.L. Roberts¹, N. Ryskulov³, S. Sedykh⁸,
Y.K. Semertzidis², P. Shagin¹⁰, Yu.M. Shatunov³, E.P. Sichtermann¹³, E. Solodov³,
M. Sossong⁸, A. Steinmetz¹³, L.R. Sulak¹, C. Timmermans¹⁰, A. Trofimov¹, D. Urner⁸,
P. von Walter⁷, D. Warburton², D. Winn⁵, A. Yamamoto⁹ and D. Zimmerman¹⁰

(Muon ($g - 2$) Collaboration)

¹*Department of Physics, Boston University, Boston, MA 02215*

²*Brookhaven National Laboratory, Upton, NY 11973*

³*Budker Institute of Nuclear Physics, 630090 Novosibirsk, Russia*

⁴*Newman Laboratory, Cornell University, Ithaca, NY 14853*

⁵*Fairfield University, Fairfield, CT 06430*

⁶*Kernfysisch Versneller Instituut, Rijksuniversiteit Groningen,
NL-9747 AA, Groningen, The Netherlands*

⁷*Physikalisches Institut der Universität Heidelberg, 69120 Heidelberg, Germany*

⁸*Department of Physics, University of Illinois at Urbana-Champaign, Urbana, IL 61801*

⁹*KEK, High Energy Accelerator Research Organization, Tsukuba, Ibaraki 305-0801, Japan*

¹⁰*Department of Physics, University of Minnesota, Minneapolis, MN 55455*

¹¹*Science University of Tokyo, Tokyo, 153-8902, Japan*

[†] Deceased.

¹² *Tokyo Institute of Technology, 2-12-1 Ookayama, Meguro-ku, Tokyo, 152-8551, Japan*

¹³ *Department of Physics, Yale University, New Haven, CT 06520*

(Dated: February 3, 2008)

Abstract

We present the final report from a series of precision measurements of the muon anomalous magnetic moment, $a_\mu = (g - 2)/2$. The details of the experimental method, apparatus, data taking, and analysis are summarized. Data obtained at Brookhaven National Laboratory, using nearly equal samples of positive and negative muons, were used to deduce $a_\mu(\text{Expt}) = 11\,659\,208.0(5.4)(3.3) \times 10^{-10}$, where the statistical and systematic uncertainties are given, respectively. The combined uncertainty of 0.54 ppm represents a 14-fold improvement compared to previous measurements at CERN. The standard model value for a_μ includes contributions from virtual QED, weak, and hadronic processes. While the QED processes account for most of the anomaly, the largest theoretical uncertainty, ≈ 0.55 ppm, is associated with first-order hadronic vacuum polarization. Present standard model evaluations, based on e^+e^- hadronic cross sections, lie 2.2 - 2.7 standard deviations below the experimental result.

precision of 0.54 ppm

Contents

I. Introduction	5
II. Experimental Method	7
A. Overview	7
B. Beamline	11
C. Inflector	15
D. Muon storage ring magnet	18
E. Electric quadrupoles	19
F. Pulsed kicker magnet	24
G. Field measurement instrumentation	26
H. Detector systems, electronics and data acquisition	29
1. Electromagnetic calorimeters	29
2. Special detector systems	33
3. Waveform digitizers and special electronics	34
III. Beam Dynamics	36
A. Overview	36
B. Fast rotation	37
C. Coherent betatron oscillations	41
D. Muon losses	43
E. Electric-field and pitch correction	47
IV. Data Analysis	48
A. Determination of ω_p and $\tilde{\omega}_p$	49
1. Absolute calibration probe	49
2. Trolley probe and plunging probe relative calibration	51
3. Measurement of azimuthal field average with trolley probes	53
4. Field tracking with the fixed probes	56
5. Average of the field over muon distribution and time	56
6. Results and systematic errors	60
B. Analysis of ω_a	60

1. Data preparation and pulse-fitting procedure	62
2. Energy calibration and stability	66
3. Correction for multi-particle pileup	67
4. Elimination of fast rotation	70
5. Multi-parameter fitting	72
6. The ratio-fitting method	77
7. The asymmetry-weighting method	78
8. Internal and mutual consistency	78
9. Systematic errors in ω_a	83
10. Consideration of a muon EDM	84
C. Final a_μ result	85
V. The Standard Model Value of the Anomaly	87
VI. Discussion and Conclusions	91
VII. Acknowledgments	93
References	94

I. INTRODUCTION

The muon magnetic moment is related to its intrinsic spin by the gyromagnetic ratio g_μ :

$$\vec{\mu}_\mu = g_\mu \left(\frac{q}{2m} \right) \vec{S}, \quad (1)$$

where $g_\mu = 2$ is expected for a structureless, spin- $\frac{1}{2}$ particle of mass m and charge $q = \pm e$. Radiative corrections (RC), which couple the muon spin to virtual fields, introduce an anomalous magnetic moment defined by

$$a_\mu = \frac{1}{2}(g_\mu - 2). \quad (2)$$

The leading RC is the lowest-order (LO) quantum electrodynamic process involving the exchange of a virtual photon, the ‘‘Schwinger term,’’ [1] giving $a_\mu(\text{QED}; \text{LO}) = \alpha/2\pi \approx 1.16 \times 10^{-3}$. The complete standard model value of a_μ , currently evaluated to a precision of approximately 0.6 ppm (parts per million), includes this first-order term along with higher-order QED processes, electroweak loops, hadronic vacuum polarization, and other higher-order hadronic loops. The measurement of a_μ , carried out to a similar precision, is the subject of this paper. The difference between experimental and theoretical values for a_μ is a valuable test of the completeness of the standard model. At sub-ppm precision, such a test explores physics well above the 100 GeV scale for many standard model extensions.

The muon anomalous magnetic moment was measured in a series of three experiments at CERN and, most recently in our E821 experiment at Brookhaven National Laboratory (BNL). In the first CERN measurement [2] muons were injected into a 6-m long straight magnet where they followed a drifting spiral path, slowly traversing the magnet because of a small gradient introduced in the field. The muons were stopped in a polarimeter outside the magnet and a measurement of their net spin precession determined a_μ with an uncertainty of 4300 ppm. The result agreed with the prediction of QED for a structureless particle. The second CERN experiment [3] used a magnetic ring to extend the muon storage time. A primary proton beam was injected directly onto a target inside the storage ring where produced pions decayed to muons, a small fraction of which fell onto stable orbits. The muon precession frequency was determined by a sinusoidal modulation in the time distribution of decay positrons, measured by detectors on the opposite side of the ring from the injection point. The result to 270 ppm agreed with QED only after the theory

had been recalculated [4]. The CERN-III experiment [5] used a uniform-field storage ring and electric quadrupoles to provide vertical containment for the muons having the “magic” momentum of 3.1 GeV/ c . At this momentum, the muon spin precession is not affected by the electric field from the focusing quadrupoles. Additionally, pions were injected directly into the ring, which resulted in a higher stored muon fraction and less background than proton injection. The CERN-III experiment achieved a precision of 10 ppm for each muon polarity. CPT symmetry was assumed, and the results were combined to give a 7.3 ppm measurement, which agreed with theory. The result served as the first confirmation of the predicted 60 ppm contribution to a_μ from hadronic vacuum polarization.

The present BNL experiment follows the general technique pioneered by CERN-III, but features many innovative improvements. A continuous superconducting magnet, having high field uniformity, is used instead of a lattice of discrete resistive magnets. A direct current, rather than pulsed, inflector magnet permits the ring to be filled at 33 ms intervals, the bunch extraction interval from the AGS. Muons are injected directly into the storage ring, which increases the storage efficiency and reduces the intense hadron-induced background “flash.” A pulsed kicker places the muons onto stable orbits and centers them in the storage region. The electrostatic quadrupoles permit operation at about twice the field gradient of the CERN experiment. The transverse aperture of the storage region is circular rather than rectangular, in order to reduce the dependence of the average field seen by a muon on its trajectory. The magnetic field is mapped using an array of NMR probes, mounted on a trolley that can be pulled through the vacuum chamber. Waveform digitizers provide a time record of energy deposition in calorimeters. The records are used to determine electron energies and times and to correct for multi-particle overlap—“pileup.” (Note: In this manuscript, we use *electron* to represent either the positron or electron in the generic $\mu \rightarrow e\nu\bar{\nu}$ decay chain.)

Combining the results of four positive muon runs and a final run using negative muons, a_μ was determined to a precision of 0.54 ppm. A summary of the CERN and BNL measurements is given in Table I. This paper reviews the BNL E821 results, all reported in Letters [6, 8, 9, 10] or Brief Reports [7]. Many of the key experimental components have been described in separate papers; brief summaries are given here. The paper begins with the basic principle of the experimental method including subsections on the apparatus. The dynamics of muon storage, which shape the observed decay electron distribution, are discussed next. Then

TABLE I: Summary of a_μ results from CERN and BNL, showing the evolution of experimental precision over time. The average is obtained from the 1999, 2000 and 2001 data sets only.

Experiment	Years	Polarity	$a_\mu \times 10^{10}$	Precision [ppm]	Reference
CERN I	1961	μ^+	11 450 000(220 000)	4300	[2]
CERN II	1962-1968	μ^+	11 661 600(3100)	270	[3]
CERN III	1974-1976	μ^+	11 659 100(110)	10	[5]
CERN III	1975-1976	μ^-	11 659 360(120)	10	[5]
BNL	1997	μ^+	11 659 251(150)	13	[6]
BNL	1998	μ^+	11 659 191(59)	5	[7]
BNL	1999	μ^+	11 659 202(15)	1.3	[8]
BNL	2000	μ^+	11 659 204(9)	0.73	[9]
BNL	2001	μ^-	11 659 214(9)	0.72	[10]
Average			11 659 208.0(6.3)	0.54	[10]

the data analysis is described and the paper concludes with a discussion of the theoretical standard model value for a_μ and its comparison to the final result.

II. EXPERIMENTAL METHOD

A. Overview

The cyclotron ω_c and spin precession ω_s frequencies for a muon moving in the horizontal plane of a magnetic storage ring are given by:

$$\vec{\omega}_c = -\frac{q\vec{B}}{m\gamma}, \quad \vec{\omega}_s = -\frac{gq\vec{B}}{2m} - (1 - \gamma)\frac{q\vec{B}}{\gamma m}. \quad (3)$$

Thomas precession

The anomalous precession frequency ω_a is determined from the difference

$$\vec{\omega}_a = \vec{\omega}_s - \vec{\omega}_c = -\left(\frac{g-2}{2}\right)\frac{q\vec{B}}{m} = -a_\mu\frac{q\vec{B}}{m}. \quad (4)$$

Because electric quadrupoles are used to provide vertical focusing in the storage ring, their electric field is seen in the muon rest frame as a motional magnetic field that can affect the

Thomas Precession

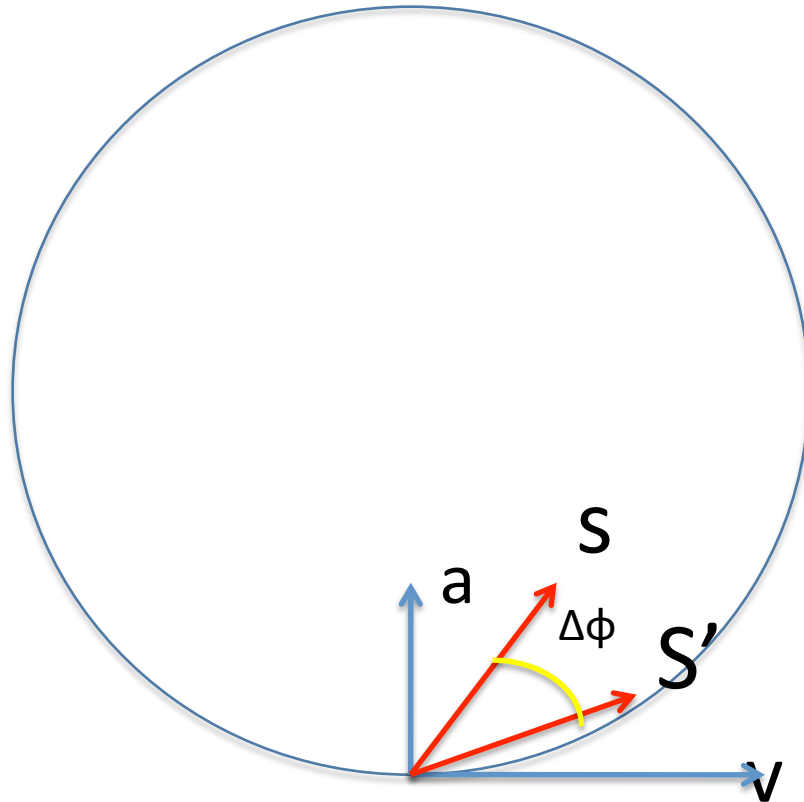

Rotation of accelerated
(primed frame) relative
To non-accelerating frame.

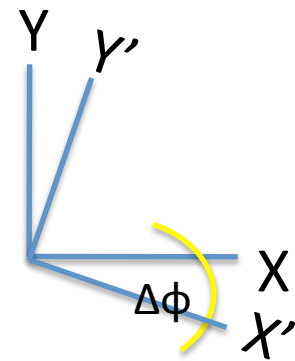

$$\Delta\phi \text{ (per rotation)} = \pi \left(\frac{v}{c}\right)^2$$

$$\vec{\omega}_T = \frac{\gamma^2}{\gamma + 1} \frac{\vec{a} \times \vec{v}}{c^2}$$

spin precession frequency. In the presence of both \vec{E} and \vec{B} fields, and in the case that $\vec{\beta}$ is perpendicular to both \vec{E} and \vec{B} , the expression for the anomalous precession frequency becomes

$$\vec{\omega}_a = -\frac{q}{m} \left[a_\mu \vec{B} - \left(a_\mu - \frac{1}{\gamma^2 - 1} \right) \frac{\vec{\beta} \times \vec{E}}{c} \right]. \quad (5)$$

The coefficient of the $\vec{\beta} \times \vec{E}$ term vanishes at the “magic” momentum of 3.094 GeV/c, where $\gamma = 29.3$. Thus a_μ can be determined by a precision measurement of ω_a and B . At this magic momentum, the electric field is used only for muon storage and the magnetic field alone determines the precession frequency. The finite spread in beam momentum and vertical betatron oscillations introduce small (sub ppm) corrections to the precession frequency.

The longitudinally polarized muons, which are injected into the storage ring at the magic momentum, have a time-dilated muon lifetime of 64.4 μs . A measurement period of typically 700 μs follows each injection or “fill.” The net spin precession depends on the integrated field seen by a muon along its trajectory. The magnetic field used in Eq. 5 refers to an average over muon trajectories during the course of the experiment. The trajectories of the muons must be weighted with the magnetic field distribution. To minimize the precision with which the average particle trajectories must be known, the field should be made as uniform as possible.

Because of parity violation in the weak decay of the muon, a correlation exists between the muon spin and decay electron direction. This correlation allows the spin direction to be measured as a function of time. In the rest frame of the muon—indicated by starred quantities—the differential probability for the electron to emerge with a normalized energy $y = E^*/E_{max}$ ($E_{max} = 52.8$ MeV) at an angle θ^* with respect to the muon spin is [11]

$$\frac{dP(y, \theta^*)}{dy d\Omega} = (1/2\pi)n^*(y)[1 - \alpha^*(y) \cos \theta^*] \quad \text{with} \quad (6)$$

$$n^*(y) = y^2(3 - 2y) \quad \text{and} \quad (7)$$

$$\alpha^*(y) = \frac{q}{e} \frac{2y - 1}{3 - 2y}. \quad (8)$$

Figure 1a shows the quantities $n^*(y)$ and $\alpha^*(y)$. Electrons with $y < 0.5$ are emitted preferentially along the (negative) muon spin direction and those with $y > 0.5$ are more likely emitted opposite to the spin. Because both n^* and α^* are larger for $y > 0.5$, decay electrons tend to emerge in the direction opposite to the muon spin. Like the muon spin, the angular distribution of the electrons in the muon rest frame rotates at the angular frequency ω_a . Figure 1b

Spin of muon tagged by decaying electron.

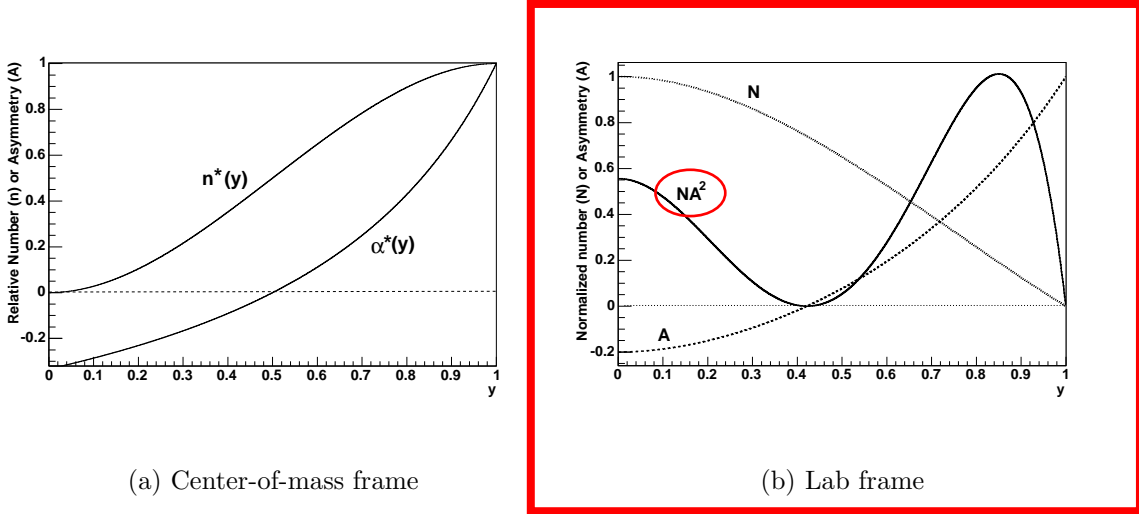

FIG. 1: Relative number and asymmetry distributions versus electron fractional energy y in the muon rest frame (left panel) and in the laboratory frame (right panel). The differential figure-of-merit product NA^2 in the laboratory frame illustrates the importance of the higher-energy electrons in reducing the measurement statistical uncertainty.

shows the same differential quantities in the boosted laboratory frame ($n^* \rightarrow N, \alpha^* \rightarrow A$) (here, $E_{max} \approx 3.1$ GeV and A is the laboratory asymmetry). As discussed later, the statistical uncertainty on the measurement of ω_a is inversely proportional to the ensemble-averaged figure-of-merit (FOM) NA^2 . The differential quantity NA^2 , shown in the Fig. 1b, illustrates the relative weight by electron energy to the ensemble average FOM.

Because the stored muons are highly relativistic, the decay angles observed in the laboratory frame are greatly compressed into the direction of the muon momenta. The lab energy of the relativistic electrons is given by

$$E_{lab} = \gamma(E^* + \beta p^* c \cos \theta^*) \approx \gamma E^* (1 + \cos \theta^*). \quad (9)$$

Because the laboratory energy depends strongly on the decay angle θ^* , setting a laboratory threshold E_{th} selects a range of angles in the muon rest frame. Consequently, the integrated number of electrons above E_{th} is modulated at frequency ω_a with a threshold-dependent asymmetry. The integrated decay electron distribution in the lab frame has the form

$$N_{ideal}(t) = N_0 \exp(-t/\gamma\tau_\mu) [1 - A \cos(\omega_a t + \phi)], \quad (10)$$

where N_0 , A and ϕ are all implicitly dependent on E_{th} . For a threshold energy of 1.8 GeV ($y \approx 0.58$ in Fig. 1b), the asymmetry is ≈ 0.4 and the average FOM is maximized. A

Parity violating muon decay

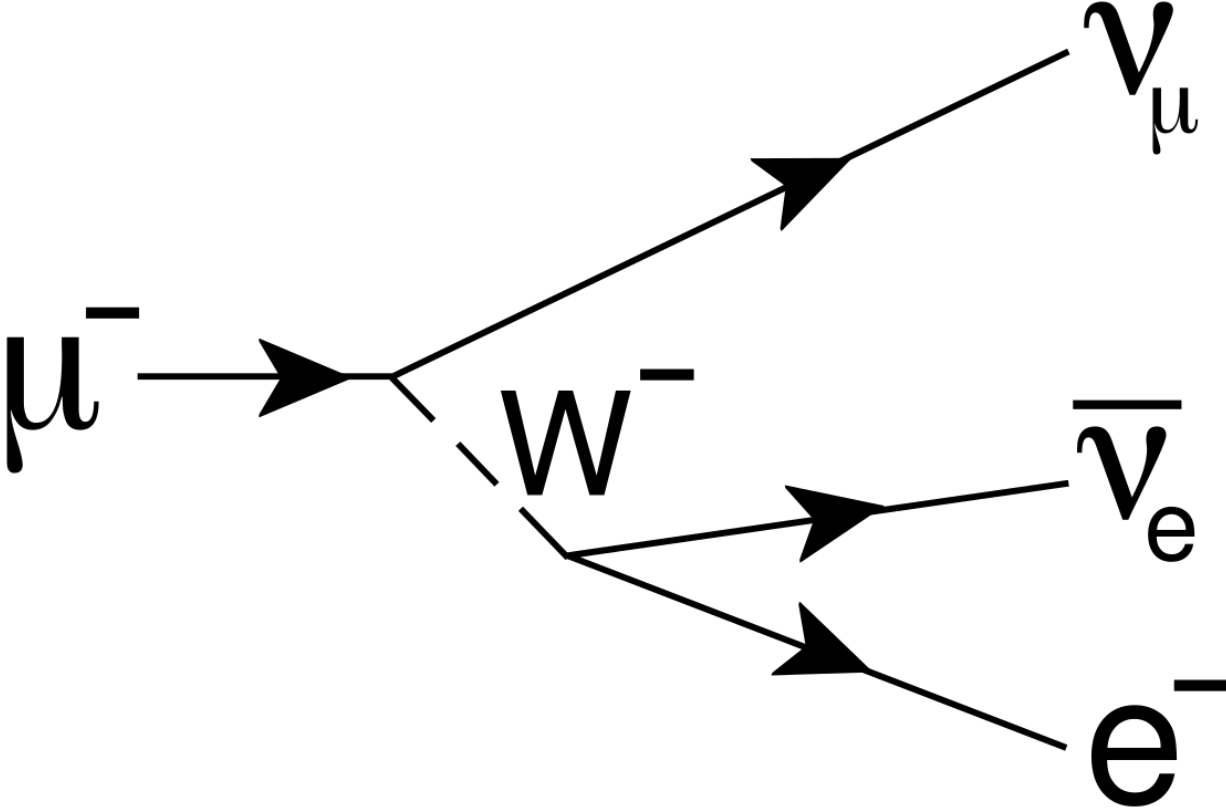

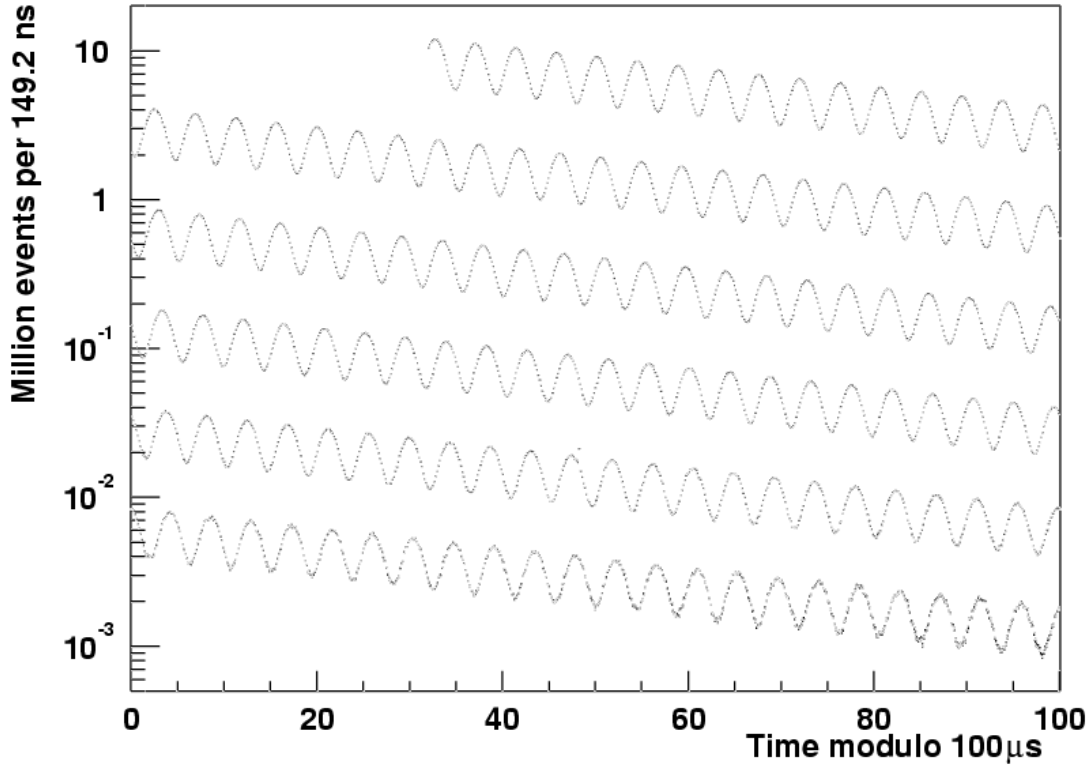

FIG. 2: Distribution of electron counts versus time for the 3.6 billion muon decays in the R01 μ^- data-taking period. The data is wrapped around modulo 100 μs .

representative electron decay time histogram is shown in Fig. 2.

To determine a_μ , we divide ω_a by $\tilde{\omega}_p$, where $\tilde{\omega}_p$ is the measure of the average magnetic field seen by the muons. The magnetic field, measured using NMR, is proportional to the free proton precession frequency, ω_p . The muon anomaly is given by:

$$a_\mu = \frac{\omega_a}{\omega_L - \omega_a} = \frac{\omega_a/\tilde{\omega}_p}{\omega_L/\tilde{\omega}_p - \omega_a/\tilde{\omega}_p} = \frac{\mathcal{R}}{\lambda - \mathcal{R}}, \quad (11)$$

where ω_L is the Larmor precession frequency of the muon. The ratio $\mathcal{R} = \omega_a/\tilde{\omega}_p$ is measured in our experiment and the muon-to-proton magnetic moment ratio

$$\text{from muonium (mu+,e-) hyperfine} \quad \lambda = \omega_L/\omega_p = 3.18334539(10) \quad (12)$$

is determined from muonium hyperfine level structure measurements [12, 13].

The BNL experiment was commissioned in 1997 using the same pion injection technique employed by the CERN III experiment. Starting in 1998, muons were injected directly into the ring, resulting in many more stored muons with much less background. Data were

TABLE II: Running periods, total number of electrons recorded 30 μ s or more after injection having $E > 1.8$ GeV. Separate systematic uncertainties are given for the field (ω_p) and precession (ω_a) final uncertainties.

Run	Polarity	Electrons	Systematic	Systematic	Final Relative
Period		[millions]	ω_p [ppm]	ω_a [ppm]	Precision [ppm]
R97	μ^+	0.8	1.4	2.5	13
R98	μ^+	84	0.5	0.8	5
R99	μ^+	950	0.4	0.3	1.3
R00	μ^+	4000	0.24	0.31	0.73
R01	μ^-	3600	0.17	0.21	0.72

obtained in typically 3-4 month annual runs through 2001. In this paper, we indicate the running periods by the labels R97 - R01. Some facts about each of the runs are included in Table II.

B. Beamline

Production of the muon beam begins with the extraction of a bunch of 24 GeV/ c protons from the AGS. The protons are focused to a 1 mm spot on a 1-interaction length target, which is designed to withstand the very high stresses associated with the impact of up to 7×10^{12} protons per bunch. The target is composed of twenty-four 150-mm diameter nickel plates, 6.4-mm thick and separated by 1.6 mm. To facilitate cooling, the disks rotate at approximately 0.83 Hz through a water bath. The axis of rotation is parallel to the beam.

Nickel is used because, as demonstrated in studies for the Fermilab antiproton source [14], it can withstand the shock of the instantaneous heating from the interaction of the fast beam. The longitudinal divisions of the target reduce the differential heating. The beam strikes the outer radius of the large-diameter disks. The only constraint on the target transverse size is that a mis-steered proton beam does not allow production from a part of the target that would result in a high flux of pions entering the storage ring during muon injection running. This region corresponds to the outer edge of the disks. Otherwise, the production target transverse size is defined by the beam size. With the large radius disks, shock damage of the

target is distributed over the disk circumference as the disks rotate. Still, it was necessary to replace the target after each running period, typically following an exposure of 5×10^{19} protons, or when nickel dust was observed in the target water cooling basin.

Pions are collected from the primary target at zero angle and transferred into a secondary pion-muon decay channel, designed to maximize the flux of polarized muons while minimizing pion contamination. A schematic representation of the beamline is shown in Fig. 3 and selected proton beam and pion beamline parameters are given in Table III. Downstream of the target, pions produced in the forward direction within a solid angle of 32 mrad (horizontal) and 60 mrad (vertical) are collected by quadrupoles Q1 and Q2. A momentum-dispersed image of the target is created at the K1-K2 slits. The momentum dispersion is 0.04%/mm and under typical running conditions the pion momentum width was $\delta p/p \sim \pm 0.5\%$. The momentum-recombined beam then traverses an 80 m quadrupole magnet FODO (alternating focusing and defocusing) straight section. A momentum dispersed image of the target is created at the K3-K4 slits. Here the momentum dispersion is 0.06%/mm. The momentum-recombined beam is then focused to allow passage through the hole in the back leg of the ring magnet, through the strong vertically focusing storage ring fringing field, the inflector, and into the storage volume. For pion injection, the K1-K2 slits select the momentum of the pion beam and the K3-K4 slits are effectively not used. For muon injection, the K3-K4 slits reject most of the pion beam and select particles having the storage ring momentum.

The beamline and ring were operated in different modes for the five running periods. In the R97 period, pions of central momentum 0.5 percent above the magic momentum were injected directly into the storage ring. With typically 5×10^{12} protons on target, 10^8 particles were injected into the muon storage ring per fill. The muon capture efficiency was 25 ppm, consistent with Monte Carlo estimates. The majority of the pions strike obstructions in the ring or decay to muons that are not stored. This initial particle “flash” induces a considerable background in the electron detectors. All subsequent running periods used direct muon injection, where muons of the magic momentum were injected into the ring and then kicked transversely onto stable trajectories.

While the momentum of the downstream section of the beamline—after the K3-K4 slits—was always set to the magic momentum of 3.094 GeV/ c , the upstream capture and decay sections were adjusted to meet the competing demands of high muon flux and low pion contamination. The number of stored muons is maximized when the upstream beamline is

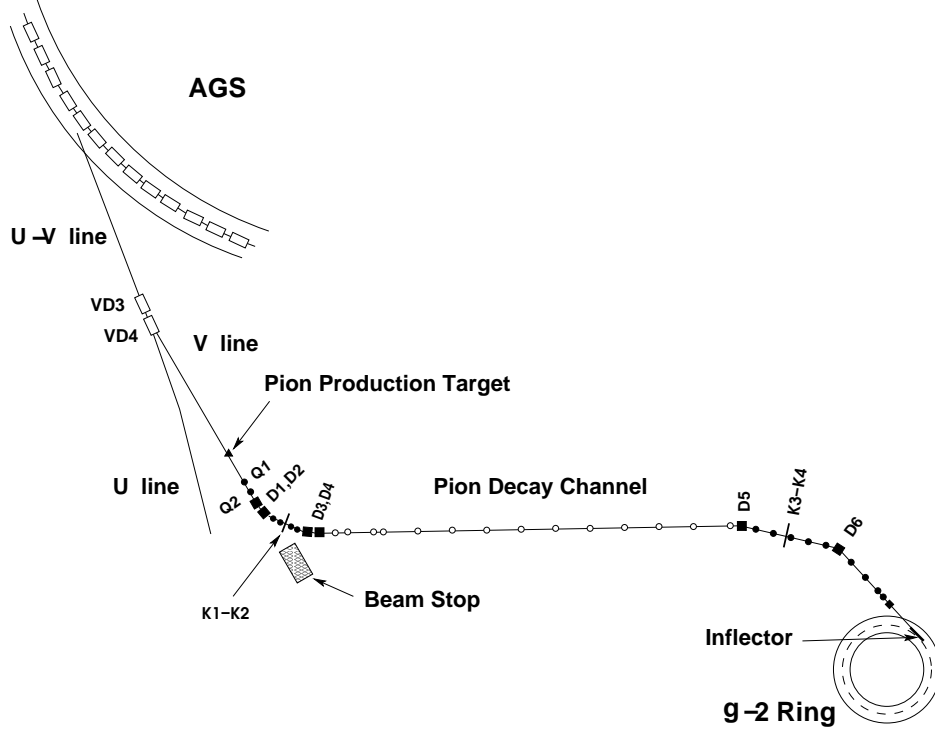

FIG. 3: Plan view of the pion/muon beamline. The pion decay channel is 80 m and the ring diameter is 14.1 m.

TABLE III: Selected AGS proton beam and secondary pion beamline characteristics

Proton Beam	Value	Pion Beamline	Value
Protons per AGS cycle	5×10^{13}	Horizontal emittance	$42 \pi\text{mm-mrad}$
Cycle repetition rate	0.37 Hz	Vertical emittance	$56 \pi\text{mm-mrad}$
Proton momentum	24 GeV/c	Inflector horizontal aperture	$\pm 9 \text{ mm}$
Bunches per cycle	6 to 12	Inflector vertical aperture	$\pm 28 \text{ mm}$
Bunch width (σ)	25 ns	Pions per proton*	10^{-5}
Bunch spacing	33 ms	Muons per pion decay**	0.012

*Captured by the beamline channel; **Measured at the inflector entrance

tuned 0.5 percent above the magic momentum. However, this small momentum difference does not provide adequate pion rejection at the K3-K4 slits.

The muon transmission to the storage ring entrance, the pion survival fraction F_π past K3-K4 (a figure of merit for pion contamination), and the muon polarization, were cal-

TABLE IV: As a function of the ratio of central-pion to muon momentum p_π/p_μ : From left to right, calculated relative muon transmission fraction; measured relative stored muon flux; calculated and measured pion transmission fraction into the ring; calculated muon polarization; measured asymmetry A using Eq. 10 and $E_{th} = 1.5$ GeV. The absolute fraction of muons per pion decay is obtained by multiplying column 2 by 0.018.

p_π/p_μ	$N_\mu(\text{Calc})$	$N_\mu(\text{Meas})$	$F_\pi(\text{Calc})$	$F_\pi(\text{Meas})$	$P_\mu(\text{Calc})$	$A(\text{Meas})$
1.005	<u>1</u>	<u>1</u>	0.78	0.80	0.99	0.22
1.010	0.5	0.43	0.29	0.30	0.98	0.26
1.015	0.29	0.21	0.04	0.065	0.96	0.30
1.017	0.25	0.17	0.002	0.016	0.96	0.30
1.020	0.18	0.12	-	0.009	0.95	0.30

culated using the BTRAF beamline transport program [15]. The results were compared to measurements (See Table IV). The muon transmission efficiency is determined by counting the number of high-energy electrons in the calorimeters in a given time period well after the hadronic flash has dissipated. The pion survival fraction is determined from beamline Čerenkov measurements (see below). The asymmetry in the observed $(g - 2)$ oscillations is proportional to the beam polarization, as well as to the asymmetry of the weak decay. It is also affected by the detector acceptance and resolution. In particular, Monte Carlo simulations using $E_{th} = 1.5$ GeV predict $A = 0.30 \pm 0.01$ for a 100 percent polarized beam. The measured asymmetry, obtained from fits of the data to Eq. 10, is found to be lower than the prediction when p_π/p_μ is in the range 1.005 – 1.010. The dilution is caused by muons born from pion decays between the target and the pion momentum selection at K1-K2, which for this small momentum difference, are transported and stored in the ring. The ratio $p_\pi/p_\mu = 1.017$ was chosen as the optimal running condition; it features a high asymmetry and storage fraction, and an acceptably low pion contamination.

Relative particle species fractions immediately downstream of the K3-K4 slit were determined using a tunable threshold gas Čerenkov counter. Table V lists the particle fractions for a positive pion beam, measured during the R98 period. The pion lifetime is $0.58 \mu\text{s}$, much less than the detector gate-on time. The fraction of pions transmitted to the storage

TABLE V: The relative fraction of e^+ , μ^+ and π^+ versus the pion-to-muon momentum ratio in the R98 period as determined by Čerenkov measurements after the K3-K4 slits. Protons are estimated to be 1/3 the pion flux.

p_π/p_μ	e^+	μ^+	π^+	π/μ
1.000	0.16	0.014	0.83	59
1.009	0.14	0.05	0.81	16
1.014	0.17	0.06	0.77	13
1.017	0.34	0.34	0.32	1

ring falls as p_π/p_μ is increased, which is expected from the momentum selection at K3-K4. However, the increase in the beam positron fraction was unanticipated. We believe it is due to radiation in the beam monitoring elements and vacuum windows between the momentum selection slits at K1-K2 and K3-K4. Positrons that are stored in the ring lose energy by synchrotron radiation; they were observed to spiral into the calorimeters during the first 5 μ s after injection. Protons, which could not be identified by the Čerenkov detector, were estimated to be about one third as numerous as the pions. Stored protons are discussed in Section III D. The antiproton flux for the R01 running period was negligible, typically suppressed by a factor of 500 compared to protons in the R00 running period.

C. Inflector

The muon beam passes through position and intensity instrumentation, through a thin vacuum window and into a 1 m long hole in the backleg of the storage ring magnet, in air. After passing through an opening in the outer coil cryostat and additional position instrumentation, it passes through a thin vacuum window into the 1.7 m long superconducting inflector magnet [16], whose 1.5 T vertical field (field integral 2.55 T·m) cancels the main storage ring field, permitting the muons to pass largely undeflected into the storage ring. The current windings feature a unique double-truncated cosine theta design [17], which minimizes the flux that leaks outside the inflector volume. The geometry at the inflector exit is shown in Fig. 4. The inflector axis is approximately tangent to the storage ring, and it is adjustable by ± 4 mrad. The beam center in the inflector channel exit is 77 mm from the

B field measured by NMR probe

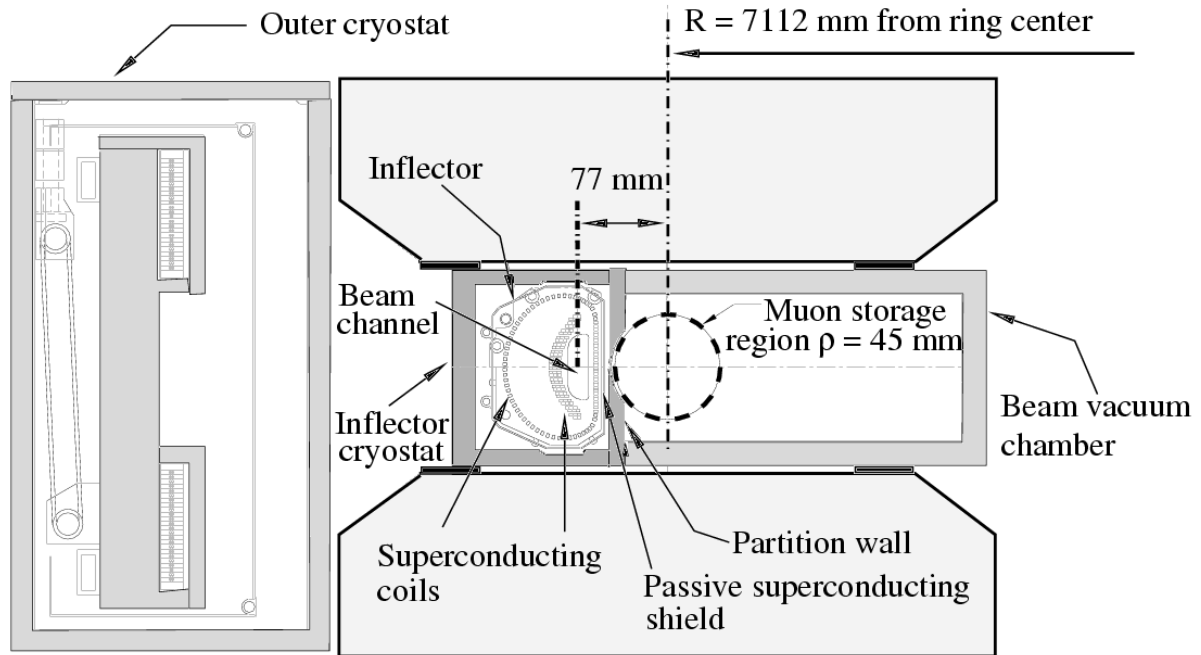

FIG. 4: The inflector/storage ring geometry. The downstream end of the inflector is shown, with the beam channel to the left of the storage region (larger radius). The ring center is to the right. Note the limited space between the pole pieces, which has to contain the inflector and its cryostat along with the beam vacuum chamber. The current in the inflector flows into the page in the “C” shaped arrangement of conductors just to the left of the beam channel, and out of the page in the conductors that form a backward “D”. The superconductor crosses over the beam channel to connect the two coils.

storage-ring center.

Placing the inflector cryostat in the limited space between the muon storage region and the outer main magnet coil restricted the inflector aperture size to $18(w)$ mm \times $56(h)$ mm, which is significantly smaller than the 90 mm diameter storage ring aperture. The small size limits the flux of incoming muons and introduces a mismatch in phase space with respect to the storage ring. Figure 5 shows the vertical and horizontal muon beam phase space (y, y' and x, x') as simulated for the exit of the inflector. Superimposed on the figures are the storage ring acceptance ellipses. The muons undergo betatron harmonic motion in the storage ring, following elliptical paths about the origin in phase space.

The precision magnetic field in the storage region is protected from the small leakage flux from the end of the inflector by means of a passive superconducting shield. The inflector is

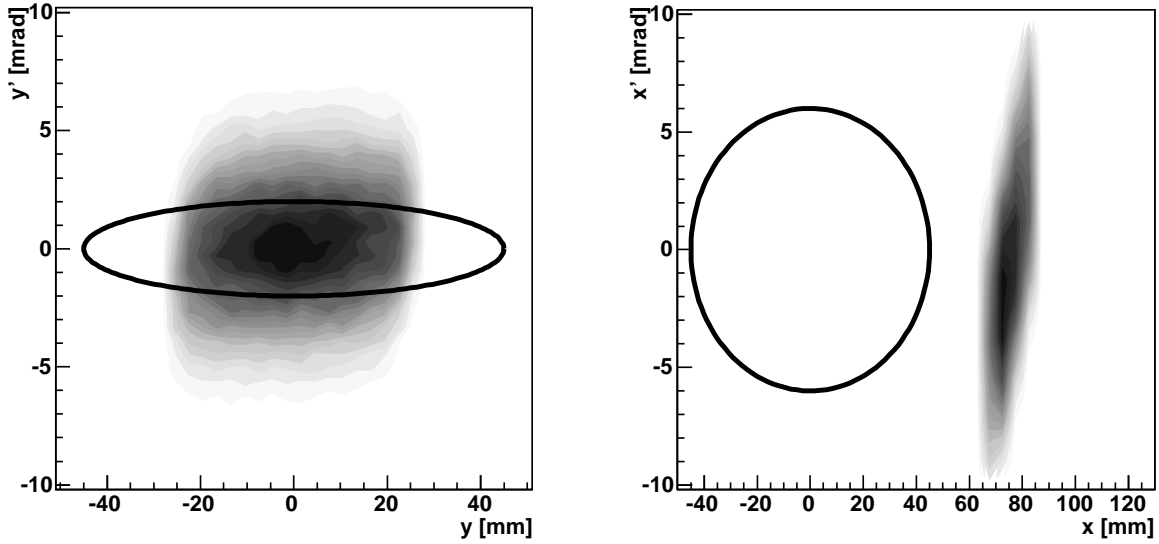

FIG. 5: The phase space plot for the inflector exit from a beam transport simulation (x is horizontal; y is vertical). Left plot: $p_y/p_z = y'$ vs. y . Right plot: $p_x/p_z = x'$ vs. x . The inflector center is displaced from the storage ring central orbit by +77 mm. The ellipses represent the storage ring acceptance. After one quarter turn, the distribution in x has rotated through 90 degrees and lies below the ring acceptance. It is then kicked toward more positive x' , into the ring acceptance.

cooled down after the storage ring magnet has been energized and the main field is stable. The superconducting shield then pins the main field and traps the inflector fringe field as the inflector is energized. The disturbance of the main storage ring field by the inflector fringe field is negligible. However, in 1997 before installing it into the ring, the first inflector required a repair, which could only be made by cutting through the shield. The resulting fringe field reduced the storage ring field by 600 ppm over a 1° azimuthal angle, resulting in unacceptable magnetic field gradients for the NMR trolley probes closest to the inflector body. The field in this region had to be mapped by a special procedure following data taking. This introduced additional uncertainty into the measurement of the average field, 0.20 ppm in the R99 result.

The damaged inflector was replaced before the 2000 running period. In the new inflector, the superconducting shield was extended further beyond the downstream end, and the lead geometry was changed to reduce the fringe field due to the inflector leads. For both the R00 and R01 running periods, the fringe field of the inflector was negligible.

D. Muon storage ring magnet

The muon storage ring [18] is a superferric “C”-shaped magnet, 7.112 m in central orbit radius, and open on the inside to permit the decay electrons to curl inward to the detectors (Fig. 6). A 5 V power supply drives a 5177 A current in the three NbTi/Cu superconducting coils. Feedback to the power supply from the NMR field measurements maintains the field stability to several ppm. The field is designed to be vertical and uniform at a central value of 1.4513 T. High-quality steel, having a maximum of 0.08 percent carbon, is used in the yoke. Low-carbon steel is used for the poles primarily because the fabrication process of continuous cast steel greatly minimizes impurities such as inclusions of ferritic or other extraneous material and air bubbles. An air gap between the yoke and the higher quality pole pieces decouples the field in the storage region from non-uniformities in the yoke. Steel wedge shims are placed in the air gap. Eighty low-current surface correction coils go around the ring on the pole piece faces for active trimming of the field. The opening between the pole faces is 180 mm and the storage region is 90 mm in diameter. A vertical cross section of the storage ring illustrating some of these key features is shown in Fig. 7. Selected storage ring parameters are listed in Table VI.

Attaining high field uniformity requires a series of passive shimming adjustments, starting far from and then proceeding towards the storage region. First the twelve upper- and lower-yoke adjustment plates are shimmed by placing precision spacers between them and the yoke steel, modifying the air gap. Next the 1000 wedge shims in the yoke pole-piece air gap are adjusted. With a wedge angle of 50 mrad, adjusting the wedge position radially by 1 mm changes the thickness of iron at the center of the storage aperture by 50 μm . The wedge angle is set to compensate the quadrupole component, and radial adjustments of the wedge and other changes to the air gap are used to shim the local dipole field. The local sextupole field is minimized by changing the thickness of the 144 edge shims, which sit on the inner and outer radial edges of the pole faces. Higher moments, largely uniform around the ring, are reduced by adjusting the 240 surface-correction coils, which run azimuthally for 360 degrees along the surface of the pole faces. They are controlled through 16 programmable current elements. With adjustments made, the azimuthally averaged magnetic field in the storage volume had a uniformity of $\simeq 1$ ppm during data-taking runs.

The main temporal variation in the magnetic field uniformity is associated with radial

TABLE VI: Selected muon storage ring parameters.

Parameter	Value
Nominal magnetic field	1.4513 T
Nominal current	5200 A
Equilibrium orbit radius	7.112 m
Muon storage region diameter	90 mm
Magnet gap	180 mm
Stored energy	6 MJ

field changes from seasonal and diurnal drift in the iron temperature. Because of the “C” magnet geometry, increasing (or decreasing) the outside yoke temperature can tilt the pole faces together (or apart), creating a radial gradient. The yoke steel was insulated prior to the R98 run with 150 mm of fiberglass to reduce the magnetic-field variation with external temperature changes to a negligible level.

E. Electric quadrupoles

Electrostatic quadrupoles are used for vertical focussing of the beam in the storage ring. Ideally, the electrodes should fill as much of the azimuth as possible; but, space is required for the kicker magnet and the inflector. For symmetry reasons, the quadrupoles are divided into four distinct regions: Q1-Q4 (see Fig. 8). Gaps at 0° and 90° for the inflector and kicker magnets, along with empty gaps at 180° and 270° provide a fourfold lattice symmetry. Overall, the electrodes occupy 43 percent of the total circumference. The fourfold symmetry keeps the variation in the beta function small, $\sqrt{\beta_{\max}/\beta_{\min}} = 1.04$, which minimizes beam “breathing” and improves the muon orbit stability.

The quadrupole voltage should be set as high as possible to maximize muon storage, subject to an upper limit of ~ 25 kV (negative muons, can be higher for positive muons) necessary for reliable operation in the vacuum chamber, which has a typical vacuum of $\sim 1.3 \times 10^{-5}$ Pa. The plates are charged prior to each fill and the voltage is held constant through the measuring period, which extends for at least $700 \mu\text{s}$. At injection, the plates are charged asymmetrically to shift the beam horizontally and vertically against a set of

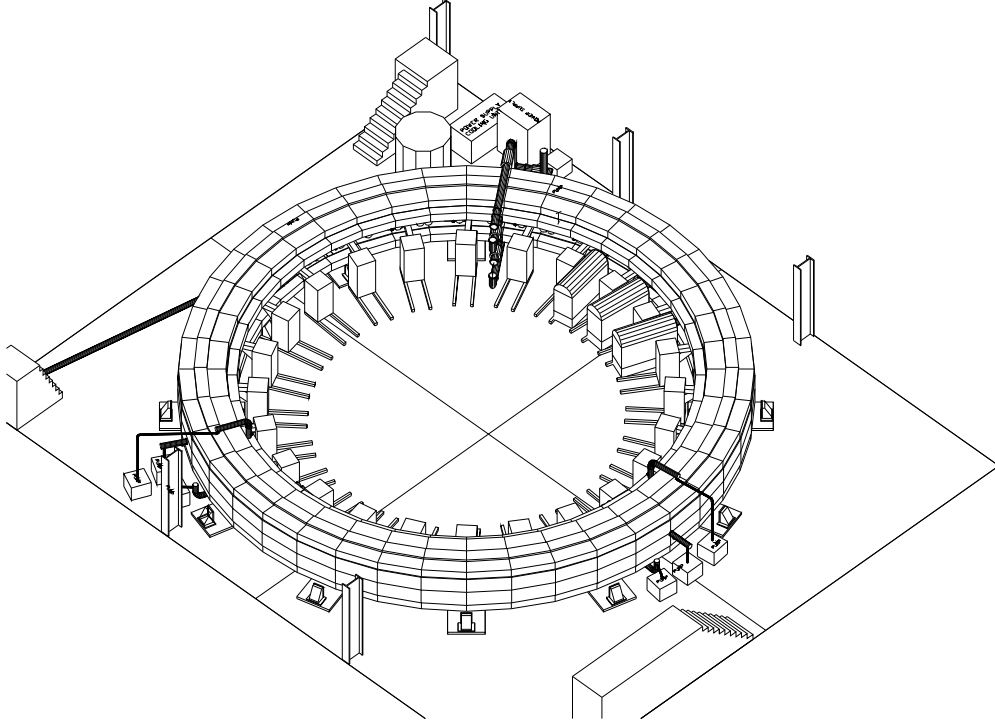

FIG. 6: A 3D engineering rendition of the E821 muon storage ring. Muons enter the back of the storage ring through a field-free channel at approximately 10 o'clock in the figure. The three kicker modulators at approximately 2 o'clock provide the short current pulse, which gives the muon bunch a transverse 10 mrad kick. The regularly spaced boxes on rails represent the electron detector systems.

centered circular collimators—the *scraping* procedure. Approximately $5 - 15 \mu\text{s}$ later, the plate voltages are symmetrized to enable long-term muon storage. The operating voltages, field indices (which are proportional to the quadrupole gradient), the initial asymmetric scraping time, and the total pulse length are given in Table VII.

A schematic representation of a cross section of the electrostatic quadrupole electrodes [19] is shown in Fig. 9. The four trolley rails are at ground potential. Flat, rather than hyperbolic, electrodes are used because they are easier to fabricate. With flat electrodes, electric-field multipoles 8, 12, 16, \dots in addition to the quadrupole are allowed by the four-fold symmetry (see Fig. 9). Of these, the 12- and 20-pole components are the largest. The ratio of the width (47 mm) of the electrode to the distance between opposite plates (100 mm) is set to minimize the 12-pole component. Beam dynamics simulations indicated that even the

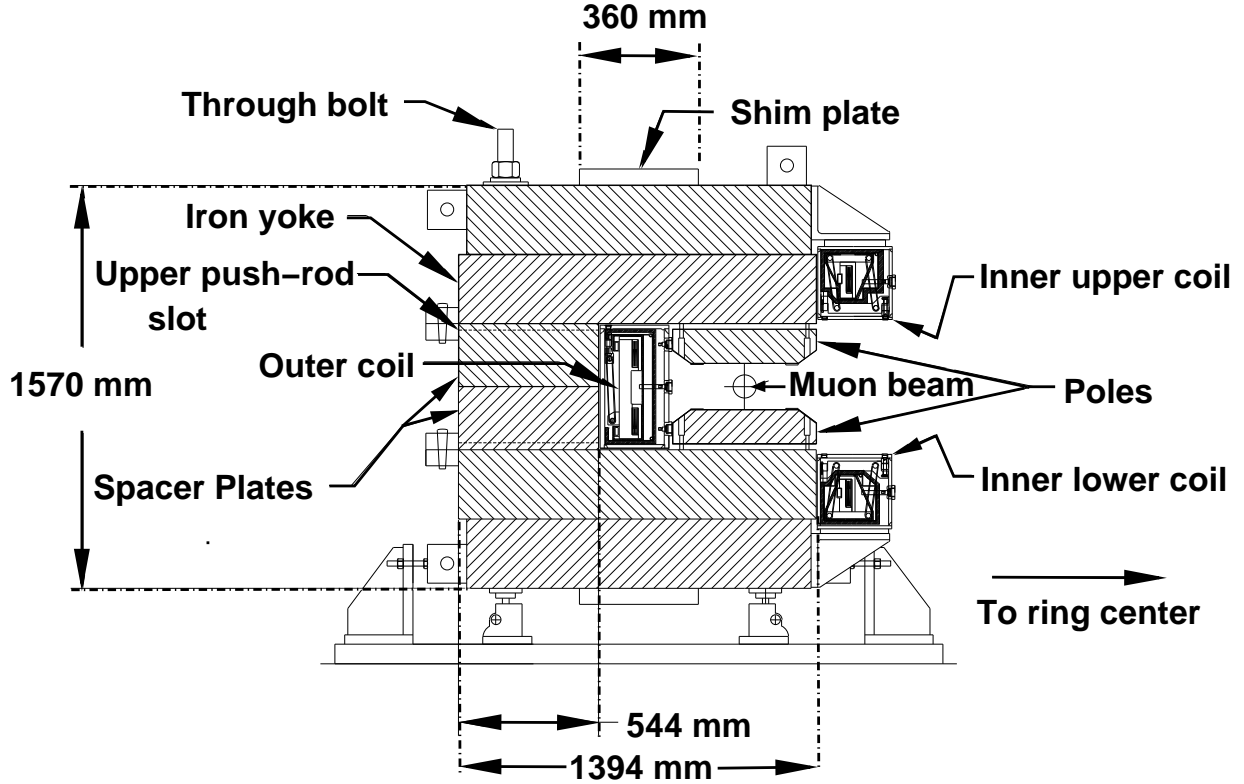

FIG. 7: Cross sectional view of the “C” magnet.

largest of the resulting multipoles, a 2 percent 20-pole component (at the circular edge of the storage region), would not cause problems with muon losses or beam instabilities at the chosen values of the field indices. The scalloped vacuum chamber introduces small 6- and 10-pole multipoles into the field shape.

The quadrupoles are charged for ≤ 1.4 ms of data taking during each fill of the ring. Cycling the quadrupoles prevents the excessive buildup of electrons around the electrodes, electrons which are produced by field emission and gas ionization and subsequently trapped in the electric and magnetic fields near the quadrupoles. Trapping was particularly severe during the R01 running period when negative muons were injected into the ring. The continuous motion of the electrons—cyclotron motion in the dipole magnetic field, magnetron motion along $\vec{E} \times \vec{B}$, and axial oscillations along the vertical axis—ionizes the residual gas and eventually produces a spark, which discharges the plates.

Slight modifications of the magnetron motion were used to quench the electron trapping. In the original design, electrons undergoing magnetron motion were trapped in horizontal

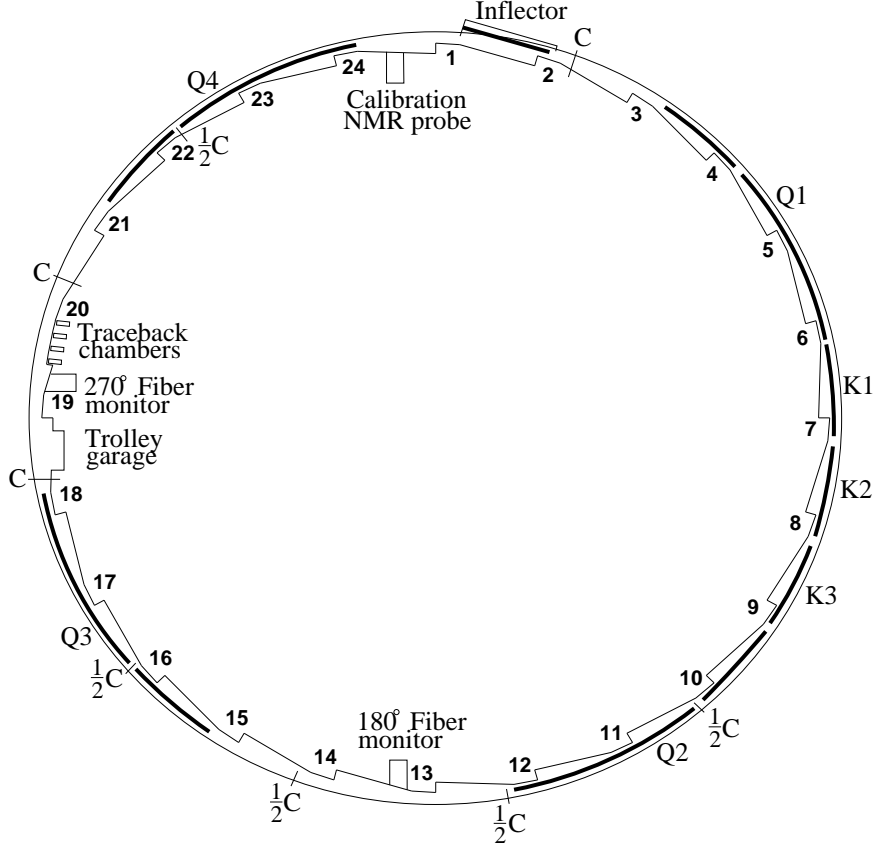

FIG. 8: The $(g-2)$ storage ring layout. The 24 numbers represent the locations of the calorimeters immediately downstream of the scalloped vacuum chamber subsections. Inside the vacuum are four quadrupole sections (Q1-Q4), three kicker plates (K1-K3) and full-aperture (C) and half-aperture ($\frac{1}{2}C$) collimators. The traceback chambers follow a truncated scalloped vacuum chamber subsection.

orbits around the vertical plates: the natural symmetry of the electric field at the ends caused the circulating electrons to re-enter the quadrupoles and return to their starting point in approximately 50 (100) μs , for the short (long) sections. To prevent the recirculation of trapped electrons, the leads were adjusted to rotate the field symmetry at the end of the plate by approximately 25° ; the resulting dipole field largely sweeps away the electrons. Also, field emission was minimized during data-taking periods by conditioning the quadrupole electrodes and by returning them to full voltage very slowly after every set of NMR trolley measurements.

In addition to creating sparks, trapped electrons can also distort the field created by

TABLE VII: Quadrupole high voltage, field index, scraping time and the total pulse length for the different running periods.

Run	HV	n	T_{scraping}	Pulse Length
Period	[kV]		[μs]	[μs]
R97	24.4	0.137	16	650
R98	24.4	0.137	16	800
R99	24.4	0.137	16	900
R00	24.2	0.136	16	1400
R01	21.7	0.122	7	700
	25.3	0.142	7	700

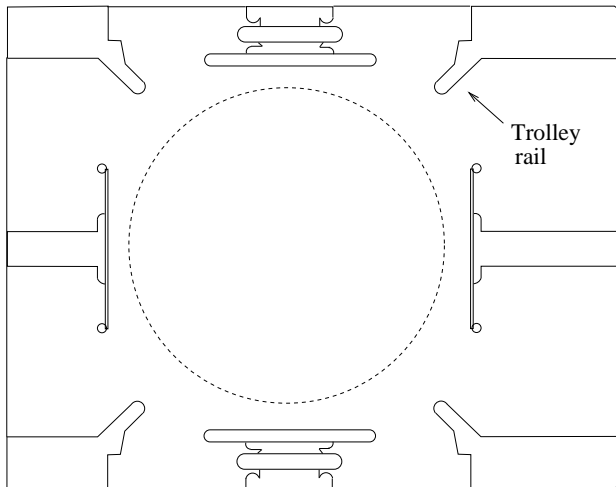

FIG. 9: Schematic view of the electrostatic quadrupoles inside the vacuum chamber. For positive muons, the top and bottom electrodes are at $\sim +24$ kV; the side electrodes are at ~ -24 kV. The NMR trolley rails can be seen between the electrodes in the $V = 0$ planes. The 90 mm diameter storage region is depicted by the dashed circle.

the quadrupole electrodes. In a quadrupole field with $E_y = ky$, the vertical oscillation frequency $\omega_A = \sqrt{ek/m_e}$ provides a direct measure of the the actual gradient k . Reducing the number of trapped electrons permitted the application of a very large dc voltage to the electrodes and, in turn, a measurement of the vertical resonance frequency of those that remained. Thus we were able to set a sensitive limit for the influence of trapped electrons

on the electric-field configuration as well as a limit on the magnetic fields that they must also produce.

F. Pulsed kicker magnet

Direct muon injection requires a pulsed kicker [20] to place the muon bunch into the phase space acceptance of the storage ring. The center of the circular orbit for muons entering through the inflector channel is offset from that of the storage ring and, left alone, muons would strike the inflector exit after one revolution and be lost. A kick of approximately 10 mrad ($\sim 0.1 \text{ T}\cdot\text{m}$) applied one quarter of a betatron wavelength downstream of the inflector exit is needed to place the injected bunch on an orbit concentric with the ring center. The ideal kick would be applied during the first revolution of the bunch and then turned off before the bunch returns on its next pass.

The E821 kicker makes use of two parallel current sheets with cross-overs at each end so that the current runs in opposite directions in the two plates. The 80-mm high kicker plates are 0.75-mm thick aluminum, electron-beam welded to aluminum rails at the top and bottom, which support the assembly and serve as rails for the 2-kg NMR trolley. The entire assembly is 94-mm high and 1760-mm long. This plate-rail assembly is supported on Macor[®] insulators that are attached to Macor[®] plates with plastic hardware forming a rigid cage, which is placed inside of the vacuum chamber. OPERA [21] calculations indicated that aluminum would minimize the residual eddy currents following the kicker pulse, and measurements showed that the presence of this aluminum assembly would have a negligible effect on the storage ring precision magnetic field.

The kicker is energized by an LCR pulse-forming network (PFN), which consists of a single capacitor, resistor, and the loop formed by the kicker plates. The capacitor is charged by a resonant circuit and the current pulse is created when the capacitor is shorted to ground at the firing of a deuterium thyratron. The total inductance of the PFN is $L = 1.6 \mu\text{H}$, which effectively limits both the peak current and the minimum achievable pulse width. The resistance is $R = 11.9 \Omega$ and the capacitance is $C = 10.1 \text{ nF}$. For the damped LCR circuit, the oscillation frequency is $f_d = 1.08 \times 10^6 \text{ Hz}$ and the decay time is $\tau_d = 924 \text{ ns}$. The peak current is given by $I_0 = V_0/(2\pi f_d L)$, where V_0 is the initial voltage on the capacitor. The resulting current pulse has a base width of $\sim 400 \text{ ns}$, which is long compared to the 149 ns

cyclotron period. Therefore, the positive kick acts on the muon bunch in the first, second, and third turns of the storage ring.

The kicker consists of three identical sections, each driven by a separate PFN; this division keeps the inductance of a single assembly at a reasonable value. In each circuit, an initial voltage of ~ 90 kV on the capacitor results in a current-pulse amplitude of approximately 4200 A. Figure 10 shows the pulse from one of the networks superimposed on a schematic representation of the time and width of the muon bunch as it passes the location of a single kicker section. While a square-wave current pulse—bracketing the injected bunch and turning off completely before the next revolution—would be ideal, the actual pulse waveform acts both positively and negatively on the bunch during the first five turns in the ring. The injection efficiency is estimated to be 3 – 5 percent. Even at this modest efficiency, direct muon injection is a significant improvement compared to pion injection, not only in storage efficiency, but also because of the reduction of the hadronic flash.

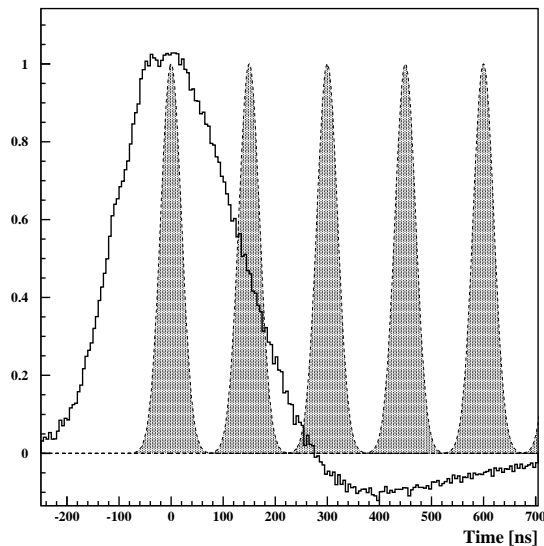

FIG. 10: The trace is a sample kicker current pulse from one of the three kicker circuits. The periodic pulses provide a schematic representation of the unmodified muon bunch intensity during the first few turns. The vertical axis is in arbitrary units.

The magnetic field produced by a prototype kicker was measured [20] using a magnetometer based on the Faraday effect. The main magnetic field, and the transient field following

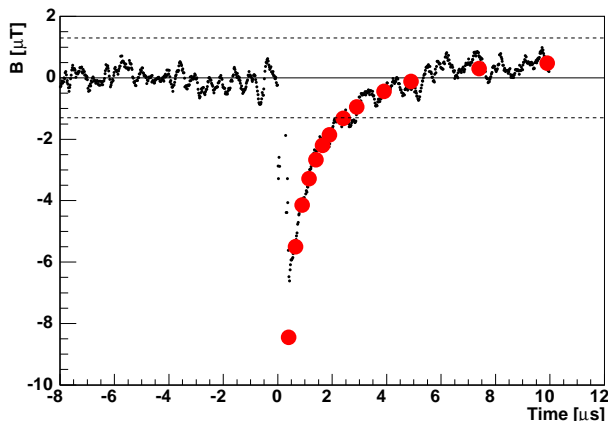

FIG. 11: The magnetic field produced mainly by eddy currents on the kicker plates as measured by an optical polarimeter with the crystal at $(x, y) = (25 \text{ mm}, 0)$ position. The kicker is fired at 95 kV, producing 4200 A at the kicker plates. The band shows the range of ± 0.1 ppm on integrated magnetic field. The large filled circles correspond to simulations with OPERA, which used the measured current pulse as the input.

the kicker pulse, were measured to a few percent. Excellent agreement was obtained between OPERA and measurement for the field at the peak of the current pulse, and for the residual magnetic field, see Fig. 11. The residual magnetic field $30 \mu\text{s}$ after the main pulse contributes less than 0.1 ppm to the integrated magnetic field seen by the muon beam.

G. Field measurement instrumentation

Precision measurements of the magnetic field are made using the free-induction decay (FID) of nuclear magnetic resonance (NMR) of protons in water [22]. The various NMR probes are calibrated with respect to an absolute calibration probe, which is a spherical sample of water (see Fig. 12(a)). The functionality of the NMR measurement system and the reliability of the absolute calibration probe were established in a wide bore superconducting magnet. The very same equipment was used to calibrate the field in a muonium microwave experiment at Los Alamos National Laboratory [12], where the Zeeman effect in the ground state was measured to obtain the muon magnetic moment. The suite of NMR probes used in E821 includes:

- A calibration probe with a spherical water sample (Fig. 12(a)), that provides an absolute calibration between the NMR frequency for a proton in a water sample to that of a free proton [23]. This calibration probe is employed at a plunging station located at a region inside the storage ring, where special emphasis was put on achieving high homogeneity of the field.
- A plunging probe (Fig. 12(b)), which can be inserted into the vacuum in the plunging station at positions matching those of the trolley probe array. The plunging probe is used to transfer calibration from the absolute calibration probe to the trolley probes.
- A set of 378 fixed probes placed above and below the storage ring volume in the walls of the vacuum chamber. These probes have a cylindrical water sample oriented with its axis along the tangential direction (Fig. 12(c)). They continuously monitor the field during data taking.
- Seventeen probes mounted inside a trolley that can be pulled through the storage ring to measure the field (Fig. 13). The probes on board the trolley are identical in design and shape to the fixed probes (Fig. 12(c)).

Initially the trolley and fixed probes contained a water sample. Over the course of the experiment, between run periods, the water samples in many of the probes were replaced with petroleum jelly. The jelly has several advantages over water: low evaporation, favorable relaxation times at room temperature, a proton NMR signal almost comparable to that from water, and a chemical shift (and thus the NMR frequency) having a negligible temperature coefficient.

The free-induction decay signals are obtained after pulsed excitation, using narrow-band duplexing, multiplexing, and filtering electronics [22]. The signals from all probes are mixed with a standard frequency $f_{ref} = 61.74$ MHz corresponding to a reference magnetic field B_{ref} . The reference frequency is obtained from a synthesizer, which is phase-locked to the base clock of the LORAN C broadcast frequency standard [24], accurate to 10^{-11} . In a typical probe, the nuclear spins of the water sample are excited by an rf pulse of 5 W and 10 μ s length applied to the resonance circuit. The coil L_s and the capacitance C_s form a resonant circuit at the NMR frequency with a quality factor of typically 100. The coil L_p serves to match the impedances of the probe assembly and the cable. The rf pulse produces

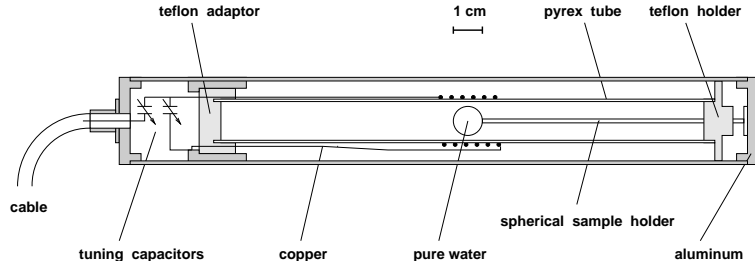

(a) Absolute calibration probe

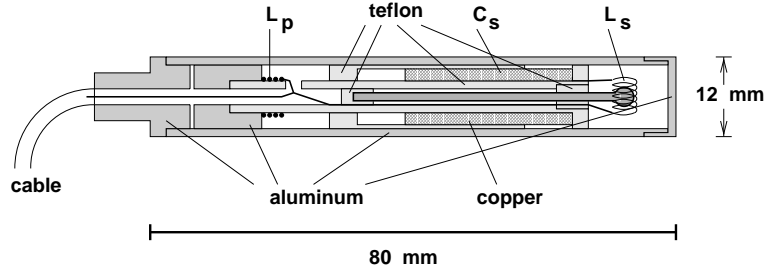

(b) Plunging probe

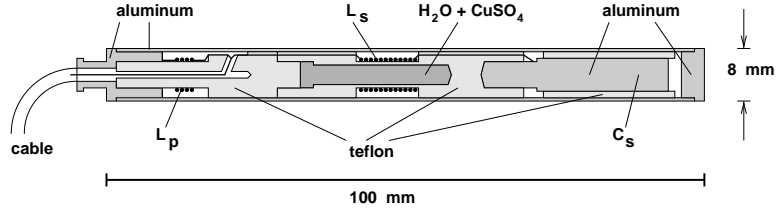

(c) Trolley and fixed probe

FIG. 12: Schematics of different NMR probes. (a) Absolute probe featuring a 10 mm diameter spherical sample of water. This probe was the same one used in Ref. [12] to determine the muon-to-proton magnetic moment ratio. (b) Plunging probe, which can be inserted into the vacuum at a specially shimmed region of the storage ring to transfer the calibration to the trolley probes. A spherical water sample is enclosed inside the coil L_s . (c) The standard probes used in the trolley and as fixed probes. The resonant circuit is formed by the two coils with inductances L_s and L_p and a capacitance C_s made by the Al housing and a metal electrode. A cylindrical water plus CuSO_4 sample of approximately 10 mm length is used.

a linearly polarized rf field \vec{H} in coil L_s , orthogonal to the dipole field. The rf pulse rotates the macroscopic magnetization in the probe by 90° . The NMR signal from the precessing magnetization at the frequency f_{NMR} is picked up by the coil L_s of the same resonance circuit and transmitted back through a duplexer to the input of a low-noise preamplifier. It is then mixed with f_{ref} to obtain the intermediate frequency f_{FID} . We set f_{ref} smaller than f_{NMR} for all probes so that f_{FID} is approximately 50 kHz. The typical FID signal decays exponentially and the time between the first and last zero crossing—the latter defined by when the amplitude has decayed to about 1/3 of its initial value [22]—is of order 1 ms. The interval is measured with a resolution of 50 ns and the number of crossings in this interval is counted. The ratio gives the frequency f_{FID} for a single measurement, which can be converted to the magnetic field B_{real} at the location of the probe’s active volume through the relation

$$B_{real} = B_{ref} \left(1 + \frac{B_{real} - B_{ref}}{B_{ref}} \right) = B_{ref} \left(1 + \frac{f_{FID}}{f_{ref}} \right). \quad (13)$$

The analysis procedure, which is used to determine the average magnetic field from the raw NMR data, is discussed in Section IV A.

H. Detector systems, electronics and data acquisition

1. Electromagnetic calorimeters

Twenty-four electromagnetic calorimeters are placed symmetrically around the inside of the storage ring, adjacent to the vacuum chamber, which has a scalloped shape to permit decay electrons to exit the vacuum through a flat face cutout upstream of each calorimeter (see Fig. 8). The calorimeters are used to measure the decay electron energy and time of arrival. They are constrained in height by the magnet yoke gap. The width and depth were chosen to optimize the acceptance for high-energy electrons, and minimize the low-energy electron acceptance. Each calorimeter is 140 mm high by 230 mm wide and has a depth of 13 radiation lengths (150 mm). The 24 calorimeters intercept approximately 65 percent of the electrons having energy greater than 1.8 GeV. The acceptance falls with decreasing electron energy.

Because of the high rate (few MHz) at early times following injection, fast readout and excellent pulse separation (in time) are necessary characteristics of the design. They are



(a) NMR Trolley

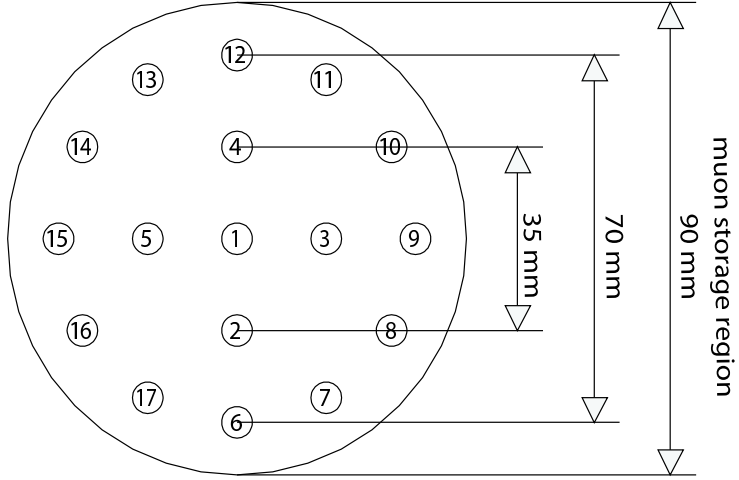

(b) Distribution of NMR probes over a cross section of the trolley

FIG. 13: Photograph of the NMR trolley, which measures the magnetic field in the storage ring. The array of 17 NMR probes, which are located inside the trolley housing, 82(1) mm behind the front of the trolley. Electronics occupies the back part of the device. At the location of the probes, the field perturbation by these materials is less than 2 ppm and is accounted for by the calibration method. The probe numbers and placement are given by the schematic.

achieved by using a plastic-scintillator-based sampling calorimeter read out by photomultiplier tubes (PMTs). The calorimeter (Pb/SciFi) volume is made of 52% lead alloy, 38% scintillating fiber, and 10% epoxy. The detector provides good light yield and, in the limited space, adequate shower containment. The 1 mm scintillating fibers are epoxied into grooved metal plates in a nearly close-packed geometry. They are oriented radially, terminating on four lightguides that pipe the light to Hamamatsu R1828 2-inch PMTs (see Fig. 14). The individual PMT gains and times were carefully balanced because the four analog signals

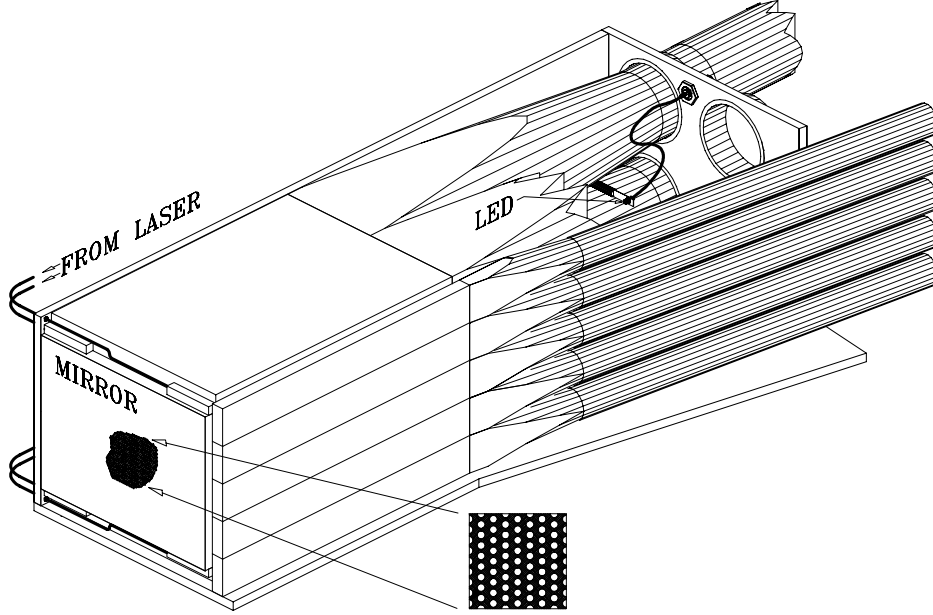

FIG. 14: Schematic of a Pb/SciFi calorimeter. The inset shows the close-pack fiber-lead grid. The detector is subdivided into four quadrants, each viewed by an independent PMT (not shown). A pulsed nitrogen laser provides a time calibration pulse into each of the four quadrants. The front scintillator hodoscope, with its five-fold segmentation, is visible on the entrance face of the calorimeter.

are added prior to sampling by a waveform digitizer. The system is described in detail in Ref. [25].

Prior to use in the experiment, each calorimeter was characterized and calibrated at the AGS test beam. The response deviates from a linear form by less than 1 percent up to 3 GeV, falling short by 2.5 percent at 4 GeV. The detector fractional energy resolution is approximately 7.0% at 1.9 GeV and scales as $1/\sqrt{E}$. While the initial absolute calibration and quadrant balancing were performed at the test beam, final PMT balancing was established and gain stability versus time was maintained by using the electron energy spectra acquired during the data collection periods. The PMTs employed transistorized bases to maintain gain stability over the very wide dynamic range of rates and background levels encountered during the data acquisition period [26].

During normal data collection, an intense burst of particles strikes the magnet pole pieces and calorimeters at the instant of injection. The detectors immediately downstream of the inflector exit are particularly affected. Because this “prompt flash” would completely

saturate the PMTs, they are gated off prior to injection and turned back on some tens of microseconds later, depending on the location of the calorimeter with respect to the inflector exit. The output of a PMT was suppressed by a factor of 10^6 by exchanging the bias on dynodes 4 and 7. When the dynodes are reset, the gain returned to better than 99 percent of its steady-state value in approximately $1 \mu\text{s}$.

The prompt flash creates an enormous number of neutrons, many of which are thermalized and captured inside the Pb/SciFi calorimeters. Capture gamma rays can knock out electrons, which traverse the scintillating fibers. The generated light gives an elevated background pedestal that diminishes with the time dependence: $\approx t^{-1.3}$ for $t > 5 \mu\text{s}$. The effective decay time was minimized by doping detectors in the first half of the ring—where the capture rate is highest—with a natural boron carbide powder. The ^{10}B component (20 percent) has a high thermal-neutron capture cross section.

To monitor the detectors, a 300 ps uv ($\lambda = 337 \text{ nm}$) pulse from a nitrogen laser is directed through a splitter system into an outside radial corner of each of the quadrants of all calorimeters. The uv pulse is absorbed by a sample of scintillating fibers. These fibers promptly emit a light pulse having the same fluorescence spectrum as produced by a passing charged particle. The calibration pulse propagates through the entire optical and electronic readout system. A reference photodiode and PMT—located well outside the storage ring—also receive a fixed fraction of the light from the laser pulse. The laser was fired every other fill, in parallel with the beam data, during 20-minute runs scheduled once per 8-hour shift. Firings alternated among four points in time with respect to beam injection. These points were changed for each laser run, providing a map of any possible gain or timing changes. Timing shifts were found to be limited to less than 4 ps from early-to-late times, corresponding to an upper limit of 0.02 ppm systematic uncertainty in ω_a . No overall trends were seen in the laser-based gain change data. Observed gain changes were generally a few tenths of a percent, without a preferred sign. Unfortunately, the scatter in these calibration measurements is much greater than is allowed by statistics, and the mechanism responsible has not been identified. Consequently, the laser-based gain stability (see Section IV B 2) could be established to no better than a few tenths of a percent. Ultimately, monitoring the endpoints of the electron energy spectra provided a better measurement of gain stability.

2. Special detector systems

Hodoscopes consisting of five horizontal bars of scintillator—the front scintillating detectors (FSDs)—are attached to the front face of the calorimeters (Fig. 14). The FSDs are used to measure the rate of “lost muons” from the storage ring and to provide a vertical profile of electrons on the front face of the calorimeters. The FSD signals are also used as a check on the pulse times reconstructed from the calorimeter waveforms. The individual scintillators are 235 mm long (radial), 28 mm high and 10 mm thick. They are coupled adiabatically to 28-mm diameter Hamamatsu R6427 PMTs, located below the storage ring magnet midplane. The PMT bases are gated off at injection, following a scheme similar to that used in the calorimeter PMT bases. (Eventually, over the run periods, about half of the FSD stations were instrumented with PMTs.) An FSD signal is recognized by a leading-edge discriminator and is recorded by a multi-hit time-to-digital converter (MTDC).

An xy hodoscope with 7 mm segmentation is mounted on the front face of five calorimeters. These position-sensitive detectors (PSDs) have 20 horizontal and 32 vertical scintillator sticks read out by wavelength-shifting fibers and a Philips multi-anode phototube (later replaced by a multi-channel DEP hybrid photodiode). The MTDC recorded event time and custom electronics coded the xy profile, providing information on albedo and multiplicity versus time. In some cases, a calorimeter was equipped with both PSD and FSD, providing efficiency checks of each. The vertical profiles of both FSD and PSD provide sensitivity to the presence of an electric dipole moment, which would tilt the precession plane of the muon spin.

Depending on the average AGS intensity for each running period, either a thin scintillator or Čerenkov counter is located in the beamline, just outside the muon storage ring. This “ T_0 ” counter records the arrival time and intensity (time) profile of a muon bunch from the AGS. Injected pulses not exceeding a set integrated current in T_0 are rejected in the offline analysis because they do not provide a good reference start time for the fill and because they are generally associated with bad AGS extraction.

Scintillating-fiber beam-monitors (FBM), which are rotated into the storage region under vacuum, were used to observe directly the beam motion in the storage ring during special systematic study runs. Separate FBMs measure the horizontal and vertical beam distributions. Each FBM is composed of seven fibers centered within the muon storage region to

± 0.5 mm. The 90-mm long fibers are separated by 13 mm. One end is mated to a clear fiber, which carries the light out of the vacuum chamber to PMTs mounted on top of the storage ring magnet. The PMTs are sampled continuously for about $10 \mu\text{s}$ using 200 MHz waveform digitizers. The beam lifetime with the fiber beam monitors in the storage region is about one half the $64 \mu\text{s}$ muon decay lifetime.

The scalloped vacuum chamber is truncated at one location and a $360 \mu\text{m}$ -thick mylar window (72 mm wide by 110 mm high) replaces the aluminum flat exit face to allow electrons to pass through a minimum of scattering material. A set of four rectangular drift chambers—the traceback system [27]—is positioned between this window and calorimeter station #20. Each chamber consists of three layers of 8-mm diameter straw drift tubes oriented vertically and radially. An electron that exits the window and passes through the four chambers is tracked by up to 12 vertical and 12 radial measurements. Although decay electrons are not always emitted tangentially, their radial momenta are sufficiently small so that an extrapolation of the track back to the point of tangency with the central muon orbit yields a measurement of the actual muon decay position, as well as its vertical decay angle. The former is helpful in establishing the average positions and therefore the average field felt by the muons.

3. *Waveform digitizers and special electronics*

Waveform digitizers (WFDs) were used to collect raw data from the PMT signals from the calorimeter and fiber monitors, and to monitor voltages in the electrostatic quadrupoles and fast kicker as a function of time. Each WFD consists of a motherboard and an application-specific daughtercard. The motherboard features four independent 8-bit digitizers with 64 kbytes of memory per channel. For the calorimeter, signals from the four phototubes are summed on the daughtercard and the resulting signal is directed into two adjacent channels on the motherboard, which sample the waveform on alternate phases of a 200 MHz clock, thus effectively providing a 400 MHz sampling rate. Data from each clock phase is written into separate memory buffers every 20 ns. Zero-suppressed operation, if invoked, is provided by comparators located on the daughtercard. For the calorimeter pulses, roughly 16 ns of the baseline are recorded prior to the time of the trigger and about 64 ns worth of samples are recorded after the trigger. For the fiber beam monitors and the quadrupole and kicker

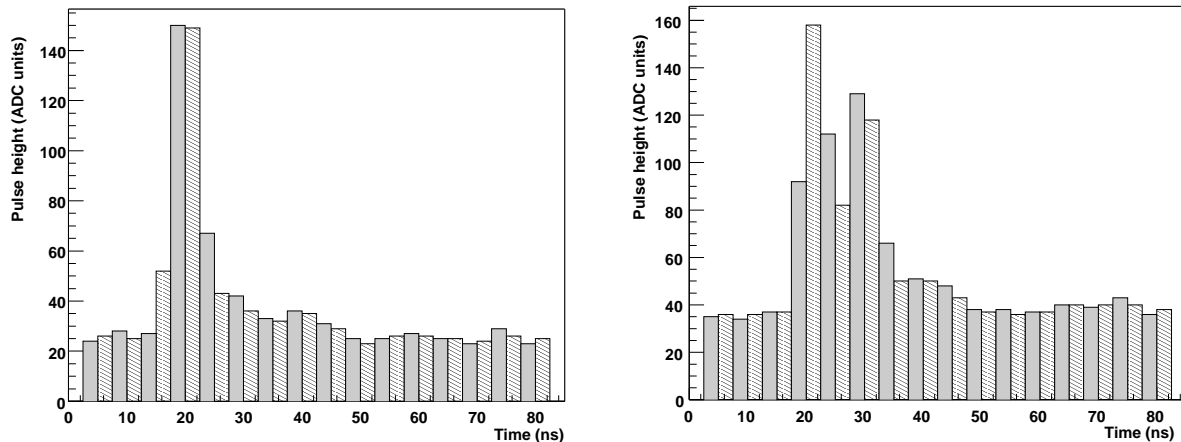

FIG. 15: Examples of waveform digitizer samples from a calorimeter. The two WFD phases are alternately shaded. The left panel shows a simple, single pulse, while the right panel has two overlapping pulses separated by 7.5 ns.

voltage readout, four different versions of the daughtercards were used. Sampling rates varied: 200 MHz for the fiber monitors and kicker, 2 MHz for the quad voltage monitor. These WFDs were operated without zero suppression.

The time words written to memory in each of the two phases have a fixed but arbitrary offset in any data-collection cycle. To resolve the ambiguity, a 150 ns triangular pulse is directed into a fifth analog input on each daughtercard immediately prior to each fill. By reconstructing this “marker pulse,” the unknown offset is determined unambiguously, and the data streams can then be combined in the offline reconstruction program. Typical calorimeter pulses, with samples from the two phases interleaved, are shown in Fig. 15.

The clock signals for the WFD, MTDC and NMR are all derived from the same frequency synthesizer, which is synchronized to the Loran C time standard [24]. There is no correlation between the experiment clock and the AGS clock that determines the time of injection. This effectively randomizes the electronic sampling times relative to the injection times at the ~ 5 ns time scale, greatly reducing possible systematic errors associated with odd-even effects in the WFDs.

III. BEAM DYNAMICS

A. Overview

The muon storage ring uses the electrostatic quadrupoles to obtain weak vertical focussing [28, 29]. The field index is given by:

$$n = \frac{R_0}{vB_0} \frac{\partial E_y}{\partial y}, \quad (14)$$

where R_0 is the central orbit radius, B_0 is the dipole magnetic field, and v is the muon speed. The coordinate system is shown in Fig. 16. High voltage of ± 24 kV applied to the quadrupole plates gives an n value of 0.137, which is the field index that was used in the R97-99 periods. The R00 period used $n = 0.135$ and the R01 running was split into “low-” and “high- n ” sub-periods with $n = 0.122$ and 0.142, respectively. The field index value determines the stored muon beam betatron motion, which in turn can perturb the electron time distribution, as discussed in Section III C.

For an ideal weak-focusing ring, where the quadrupole field is constant in time and uniform in azimuth, the horizontal and vertical tunes are given by $\nu_x = \sqrt{1-n}$ and $\nu_y = \sqrt{n}$. Consider the motion of a particular muon having momentum p compared to the magic momentum p_0 . Its horizontal and vertical betatron oscillations are described by

$$x = x_e + A_x \cos(\nu_x \phi + \phi_{0x}) \quad (15)$$

$$y = A_y \cos(\nu_y \phi + \phi_{0y}). \quad (16)$$

Here $\phi = s/R_0$, where s is the azimuthal distance around the ring and A_x and A_y are amplitudes of the oscillations about the equilibrium orbit (x_e) and the horizontal midplane, respectively, with x_e given by

$$x_e = R_0 \left(\frac{p - p_0}{p_0(1 - n)} \right). \quad (17)$$

The maximum accepted horizontal and vertical angles are defined by the 45 mm radius of the storage volume, r_{max} , giving

$$\theta_{max}^h = \frac{r_{max} \sqrt{1-n}}{R_0} \quad (18)$$

$$\theta_{max}^v = \frac{r_{max} \sqrt{n}}{R_0}. \quad (19)$$

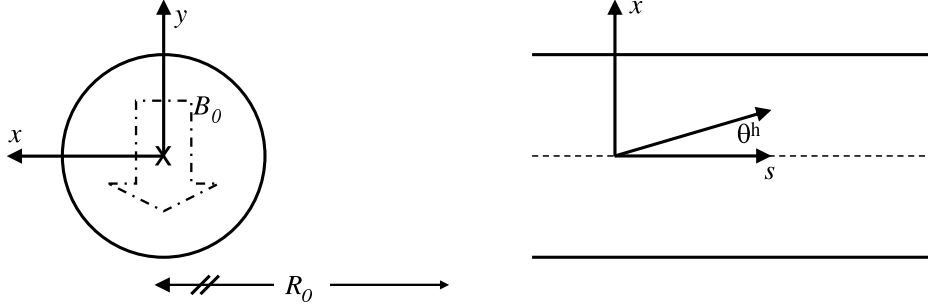

FIG. 16: Coordinate system used to define the beam dynamics expressions. An end view (left panel) with the negative muon beam into the page; the center of the storage ring is to the right, off the scale of this figure. The magnetic dipole field is oriented down. A top view (right panel) with the beam travelling in the $+s$ direction.

In general, the muon storage fraction increases for higher quadrupole voltage. The number of stored muons is plotted versus high voltage in Fig. 17. As the high voltage is increased, the vertical phase space increases, while the horizontal phase space decreases. The operating quadrupole high voltage is chosen to avoid the beam-dynamics resonances, which take the form $L\nu_x + M\nu_y = N$, where L , M , and N are integers. The resonance lines and the storage ring working line given by $\nu_x^2 + \nu_y^2 = 1$ are shown in Fig. 18. Typical working values are $\nu_x = 0.93$ and $\nu_y = 0.37$ for $n = 0.137$, giving $\theta_{max}^h = 5.9$ mrad and $\theta_{max}^v = 2.3$ mrad.

Numerical calculations, which include the finite extent of the quadrupole electrodes, were used to select the exact high-voltage values. Confirmation of resonance-induced muon losses was made during special runs tuned to the resonances $\nu_x + 3\nu_y = 2$ and $2\nu_x + 3\nu_y = 3$ ($n = 0.126$ and $n = 0.148$).

B. Fast rotation

The stored muon momentum distribution is determined by analyzing the debunching of the beam shortly after injection. This *fast rotation* analysis is based on a few simple ideas. High-momentum muons trace a larger average radius of curvature than low-momentum muons. However, because all muons travel at the same speed ($0.9994c$, constant to a part in 10^5 over the aperture), the higher (lower)-momentum muons have a smaller (larger) angular frequency. A finite range in angular frequencies causes the initial bunched beam to spread

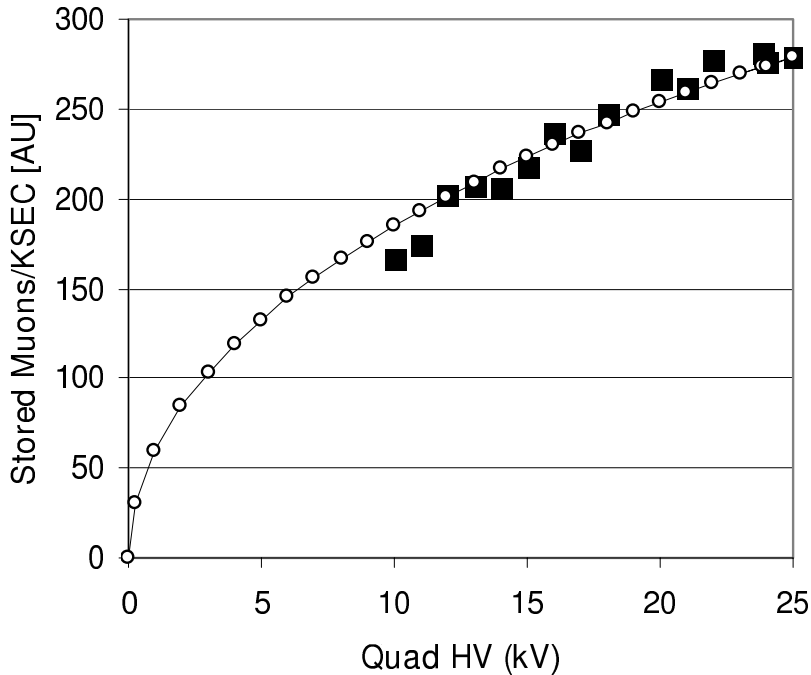

FIG. 17: The normalized number of stored muons (squares) and the expected dependence (circles) for short runs varying the quadrupole high voltage. Here, KSEC is a relative measure of the proton intensity at the target as viewed by a secondary emission counter.

azimuthally over time. Figure 19 shows the decay electron rate at one detector station from 10 to 20 μs following injection. The rapid rate fluctuation reflects the 149 ns cyclotron period of the bunched beam. The slower modulation is caused by the $(g - 2)$ spin precession. The rapid bunch structure disappears over time, as the beam uniformly fills the ring in azimuth.

The initial bunched beam is modelled as an ensemble of particles having an unknown frequency distribution and a narrow time spread (rms ~ 25 ns, occupying ~ 60 degrees of the ring). The model assumes that every time slice of the beam has the same frequency profile but the time width is left as a fit parameter, as is the exact injection time. The distribution of angular frequencies will cause the bunched beam to spread out around the ring over time, in a manner that depends uniquely on the momentum distribution. In particular, the time evolution of any finite frequency slice is readily specified. A given narrow bin of frequencies contributes linearly to the time spectrum. The total time spectrum is a sum over many of these frequency components, with amplitudes that can be determined using χ^2 minimization. The momentum distribution is then determined from the frequency

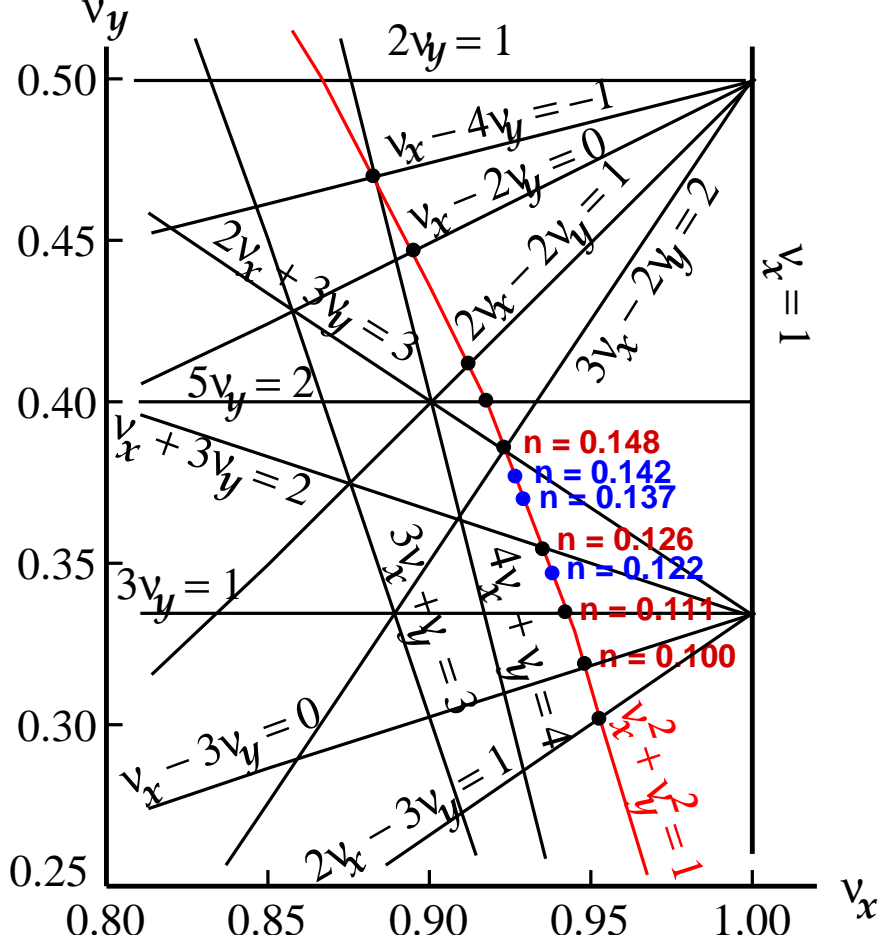

FIG. 18: The tune plane showing resonance lines. Three of the n values used to run the experiment, 0.122, 0.137, 0.142, are indicated on the arc of the circle defined as $v_x^2 + v_y^2 = 1$. They do not intersect any of the resonance lines, contrary to nearby tunes, which are also shown on the arc.

distribution (or equivalently, from the radial distribution) by

$$\frac{p - p_0}{p_0} = (1 - n) \left(\frac{R - R_0}{R_0} \right). \quad (20)$$

The result of the fast-rotation analysis from the R00 period is shown in a plot of the beam radius-of-curvature distribution shown in Fig. 20. The smooth curve is obtained from a modified Fourier transform analysis. The peak of the distribution lies below the nominal magic radius of 7112 mm but the mean is somewhat larger, 7116 ± 1 mm for R00 and 7115 ± 1 mm for R01. The rms width is about 10 mm.

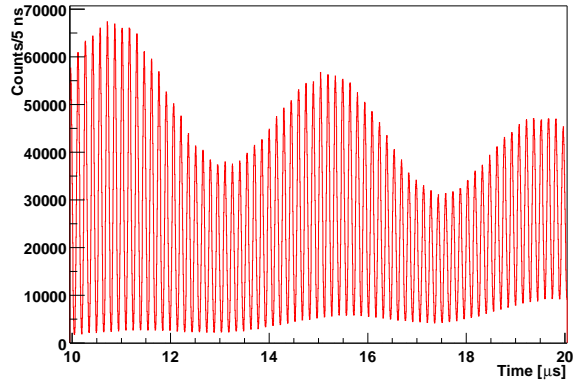

FIG. 19: Intensity at a single detector station shortly after injection. The rapid modulation repeats at the cyclotron frequency as the muon bunch circles the ring. The width of the bunch grows with time because of the finite $\delta p/p$ of the stored muons. The slow variation in the maximum amplitude is at the $(g - 2)$ frequency.

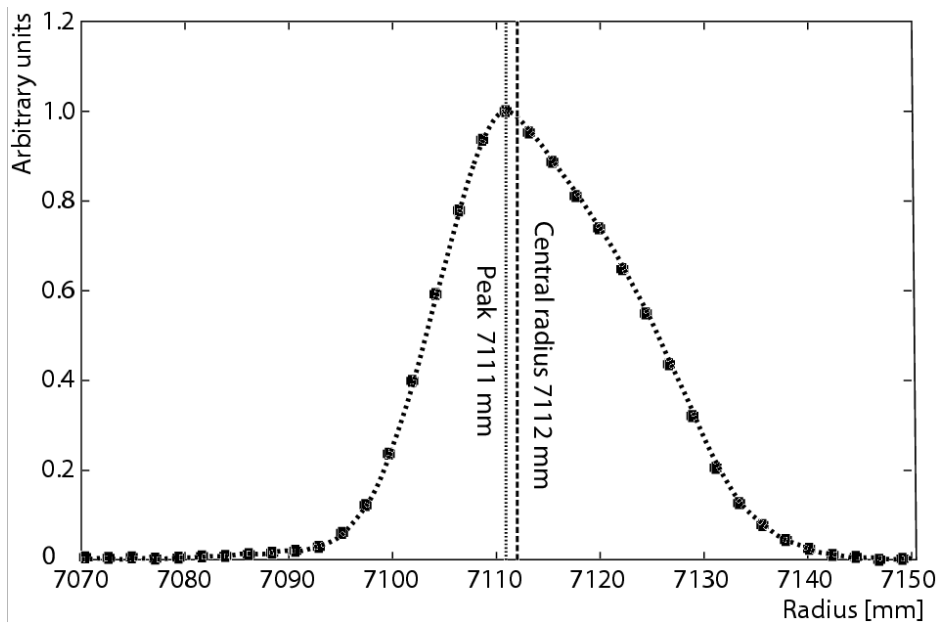

FIG. 20: The distribution of equilibrium radii dN/dx_e , as determined from the fast-rotation analysis. The dashed vertical line is at 7112 mm, the magic radius; the dotted line is at 7111 mm. The solid circles are from a de-bunching model fit to the data, and the dashed curve is obtained from a modified Fourier analysis.

C. Coherent betatron oscillations

Special short runs were devoted to observing the muon beam motion directly using the scintillating fiber beam monitors (FBM) described in Section II H 2. Figure 21 shows pedestal-subtracted data from the FBM, which sits ~ 180 degrees around the ring from the inflector exit. Data from fibers 2, 4, and 6 (where 4 is the central fiber) are shown. The left (right) panel shows the fiber intensity representing the radial (vertical) profile of the beam versus time shortly after injection. The average size of the signal across the aperture versus time reveals the longitudinal motion of the bunched beam at one point in the storage ring. The rapid oscillation (period = 149 ns) in intensity, which is approximately in phase for every fiber, corresponds to the cyclotron motion of the beam.

The *relative* size of the signals determines the moments of the transverse distributions, which oscillate in time. Oscillations in the width arise from a mismatch between the inflector and storage ring apertures. The former is 18 mm and the diameter of the latter is 90 mm. A narrow “waist” is therefore imposed on the beam at injection, which then alternately widens and narrows as the beam circulates. Because the deflection provided by the kick is smaller than that required to center the beam in the storage aperture, the centroid of the beam oscillates. When the beam is observed at one location (e.g., at a particular detector station), the width and centroid oscillate at frequency

$$f_{CBO} \approx f_c - f_x = f_c(1 - \sqrt{1 - n}) \approx 476 \text{ kHz},$$

the coherent betatron oscillation (CBO) frequency. The corresponding period is 14.1 turns.

Prominent oscillations are evident in both the mean and width of the radial distributions measured with the FBM. In the left panel of Fig. 21, the traces are stacked from top to bottom corresponding to the intensity of the muons at low, central, and high radii within the storage aperture. The vertical arrow illustrates a time when the bunch width is narrow in radial profile. It reaches a maximum width approximately $1.1 \mu\text{s}$ later. The breathing frequency corresponds to the horizontal CBO, which for this R01 low- n period data, is ~ 425 kHz. The fact that the inner and outer radial fiber intensities peak somewhat out of phase indicates that the mean radial position oscillates, again, at the same CBO frequency.

The interference of multiple frequencies is also apparent in the vertical profiles shown—with a different time axis range—in the right panel of Fig. 21. The top-to-bottom beam

TABLE VIII: Important frequencies and periods in the $(g - 2)$ storage ring for $n = 0.137$.

Physical frequency	Variable	Expression	Frequency	Period
Anomalous precession	f_a	$\frac{e}{2\pi m} a_\mu B$	0.23 MHz	4.37 μ s
Cyclotron	f_c	$\frac{v}{2\pi R_0}$	6.71 MHz	149 ns
Horizontal betatron	f_x	$\sqrt{1-n}f_c$	6.23 MHz	160 ns
Vertical betatron	f_y	$\sqrt{n}f_c$	2.48 MHz	402 ns
Horizontal CBO	f_{CBO}	$f_c - f_x$	0.48 MHz	2.10 μ s
Vertical waist	f_{VW}	$f_c - 2f_y$	1.74 MHz	0.57 μ s

intensity is given by the three shown fiber traces, which are stacked in the same sense. While the dominant feature is the repetitive cyclotron frequency, a slower, undulating pattern can also be seen. This pattern—with a period roughly indicated by the two vertical dashed lines—is related to the vertical oscillations of the beam. Recall that the phase space simulation plots in Fig. 5 show that the beam initially fills only the central 56 mm of the storage aperture because it is limited by the height of the inflector channel. However, after one quarter of a vertical betatron oscillation, it fills the full 90 mm. The minimum width at 56 mm is called the vertical waist (VW) (see, for example halfway between the dashed lines in the figure, where the outer intensities are small). The vertical width is modulated at frequency $(1 - 2\sqrt{n})f_c \approx 2.04$ MHz (low- n R01 data). The period is ~ 3.3 turns, or 0.49 μ s.

The frequencies associated with the various beam motions are revealed in Fourier analyses of both the fiber monitor and muon-decay electron time spectra. However, the lifetime of the oscillations can only be determined by the latter measurements, which do not affect the beam directly. The observed CBO lifetime is about 100 – 140 μ s. The VW lifetime is much shorter, about 25 μ s. These lifetimes are determined primarily by the tune spread. For the CBO, $\Delta\nu_x = \Delta n / (2\sqrt{1-n})$. For the VW, $\Delta\nu_y = \Delta n / (N\sqrt{n})$ where N is the harmonic of the CBO frequency. From the FBM data, the VW has CBO frequency harmonics with relative amplitudes: 0.6, 0.28, 0.08 and 0.04 for $N = 1, 2, 3,$ and 4, respectively. The observed lifetimes imply an effective field index spread of $\Delta n \simeq \pm 10^{-3}$, in agreement with computer simulations. A summary of important frequencies for the case $n = 0.137$ is given in Table VIII.

The electron traceback system makes a more direct, but still non-destructive, measure-

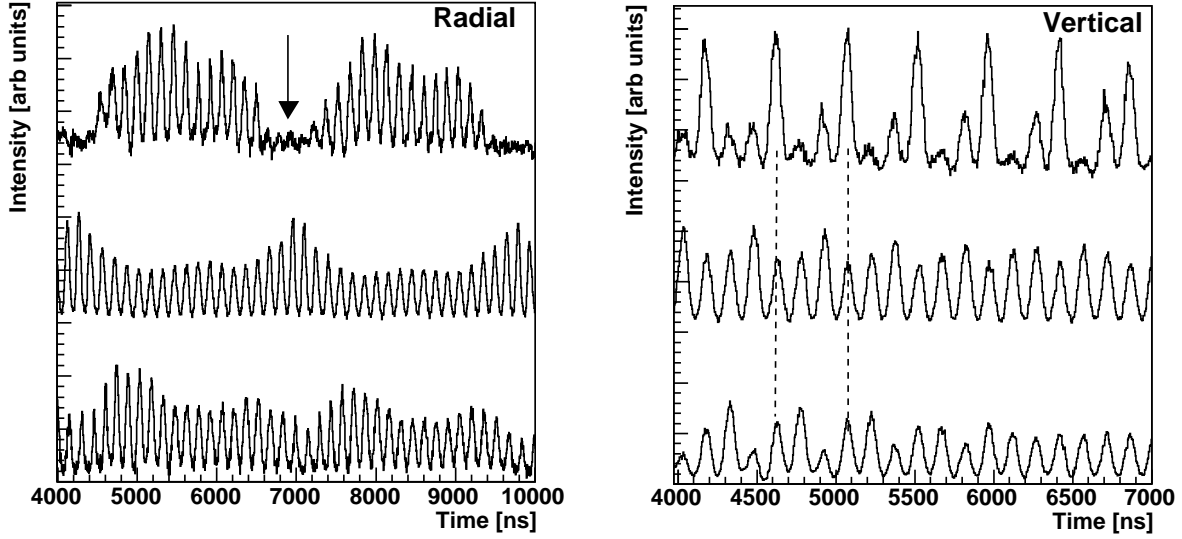

FIG. 21: Digitized waveform from the FBM located 180° from the inflector. The fast rotation period is observed in both the vertical and the horizontal profiles. Left panel: Radial profile from an inner, middle, and outer fiber trace (stacked top to bottom with an offset). The width minimum is indicated by the arrow. The outer fibers do not peak at the same time because the radial mean is oscillating at the same frequency as the width. Right panel: The vertical profile from a top, middle and bottom fiber. The two dashed lines are placed at approximately 3.3 turns, the period of the vertical betatron oscillation. A vertical waist is apparent halfway between the dashed lines.

ment of the muon phase space. Figure 22 shows a representative distribution of the radial mean and width of the muon population from 110 to 150 μs after injection during the R99 period. The fundamental CBO frequency is the dominant feature of both plots. The amplitude is damped with an exponential lifetime consistent with that found in other studies.

D. Muon losses

Small perturbations in the magnetic or electric fields couple to the horizontal and vertical betatron oscillations. If the forces arising from these perturbations are periodic, the amplitude of the oscillatory motion can grow without bound until the muon is lost. The losses are minimized by choosing a field index that does not lie on one of the resonance lines shown in

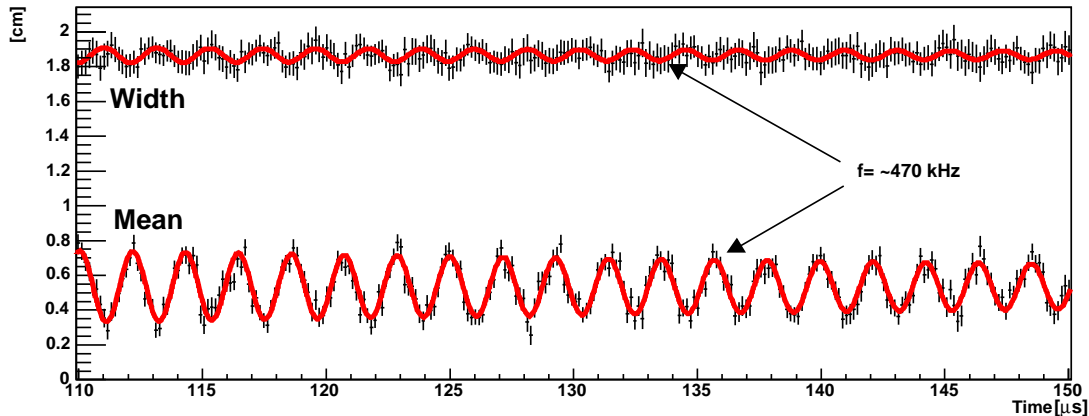

FIG. 22: The radial mean and rms width as determined by the traceback detector system in the R99 period. Note that the width includes resolution smearing; the true width is ≈ 1.55 cm. Each fit (solid lines) includes a damped exponential and an oscillatory term having the frequency of the horizontal CBO effect.

Fig. 18, by minimizing the electric and magnetic field perturbations, and by “scraping” the beam during the first $7 - 16 \mu s$ after injection.

Two perturbations of the field are of particular concern: a non-zero average radial component of the magnetic field and the component of the main dipole field that varies as $\cos(s/R_0)$. The latter, the first harmonic component, displaces the orbit horizontally. It was measured with the NMR system and shimmed at the beginning of each running period to be less than 30 ppm, well below the target upper limit of 240 ppm. Monthly variations were kept under 20 ppm. A non-zero radial field displaces the average orbit vertically. The radial magnetic field was adjusted using current shims so as to maximize the number of stored muons. This centered the beam height to ± 0.5 mm with respect to the collimators.

Beam scraping, which is discussed in detail in Ref. [19], refers to the application of asymmetric voltages to the quadrupole plates shortly after injection. Scraping eliminates muons having trajectories close to the collimators. The scraping procedure displaces the beam downward by about ~ 2 mm and re-centers the central orbit in the horizontal plane, moving it ~ 2 mm inward within two of the quadrupole regions and ~ 2 mm outward in the other two regions. Muons at the extreme edges of the storage ring phase space then strike a collimator (see below) and are removed from the ring. The quadrupole plate voltages are

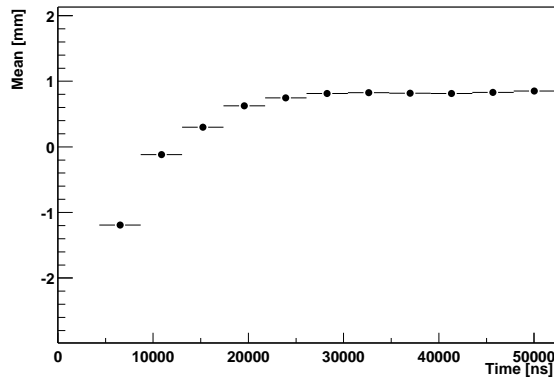

FIG. 23: Mean vertical position of the beam as measured by FSD Station 22 during the R01 period. The beam moves vertically with a time constant of $5 \mu\text{s}$ after the end of scraping.

restored to symmetric values (with a $5 \mu\text{s}$ time constant) after 7 to $15 \mu\text{s}$ (see Table VII). The reduced effective aperture typically results in a 10 percent loss of stored muons, in agreement with analytical calculations and computer tracking simulations. The effect of scraping on the average height of the muon distribution as a function of time, as measured with the FSD counters, is shown in Fig. 23. The mean beam position for Station 22 in the R01 period starts a little over 1 mm low and rises as the scraping voltages are turned off.

The collimators, which define the muon storage region, are made of 3-mm thick copper. They have an inner radius of 45 mm and an outer radius of 55 mm. Eight locations are available for the collimators in the bellows adjoining the vacuum chambers (three more are blocked by the kicker and one is unused due to proximity to the inflector exit). The inner half circles of the four collimators opposite the inflector are removed in order to avoid scattering those low-momentum muons which, because of only a two-thirds kick on the first turn, would otherwise strike the collimators on the first turn and be lost.

The muon decay fitting function $N(t)$ must account for muon losses. A fit to the simple function $f = Ce^{-t/\gamma\tau}$, for data binned in the $(g - 2)$ period and for times $t \geq 300 \mu\text{s}$, gives a satisfactory description of the data. However, an extrapolation of the fit back to early times reveals that the data lie above the fit as shown in the ratio of data to fit in Fig. 24, demonstrating that the fractional loss of muons is greater early in the measurement period.

The relative rate of muon losses can be measured directly using a coincidence of three FSD scintillator hits in three successive detector stations. A 3.1 GeV muon loses approximately

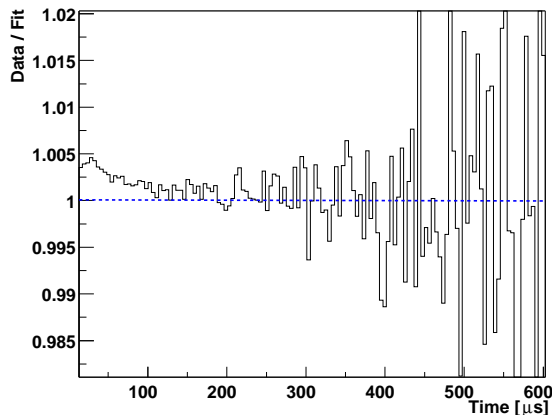

FIG. 24: A fit to the simple function, $f = Ce^{-t/\gamma\tau}$ is made for the time period 300 – 600 μs after injection for a subset of the pileup-subtracted R01 data. The fit is extrapolated back to early times and the ratio data to fit is plotted for all times. The excess of data compared to the fit at early times indicates the non-constant loss rate with time. The bin width is the $(g - 2)$ period.

100 MeV by ionization in each calorimeter, well below the WFD hardware threshold. A muon loss event therefore consists of a threefold FSD coincidence with no accompanying calorimeter signal. After random-coincidence background subtractions, the time-dependent loss function is constructed, up to an unknown efficiency factor, which is typically about 6 percent.

Beam protons were stored during the positive muon run periods R97-R00. Like muons, a fraction of these protons exit the ring because of orbit perturbations. While proton losses have a negligible effect on the decay positron distribution, they do form a significant background to the lost muon spectrum, which must be removed. A proton loss event is defined as a muon loss candidate having large energy in the third calorimeter, presumably from a hadronic shower. The proton loss signal was studied using data acquired when the quadrupole voltages were dropped to zero, long after all muons had decayed in a given fill. The uncertainty in the shape of the muon loss spectrum is dominated by uncertainty in the proton-loss component—assuming, in addition, that the muon-loss monitor samples a constant fraction of the actual ring losses versus time in the fill. The antiproton component for the R01 period with negative muons was negligible.

E. Electric-field and pitch correction

The magnetic field is adjusted so that the magic momentum p_0 (see Eq. 5) is at the center of the aperture. The $(g - 2)$ precession ω_a of muons at this radius is not affected by the electric field, which is, in any case, zero at the center of the quadrupoles. However, muons of higher or lower momentum are subject to a linearly rising field and deviate from the magic momentum, so their $(g - 2)$ frequency is reduced. We apply a correction for this effect. As the muons oscillate about their equilibrium radii x_e , they experience a mean radial electric field $\langle E_r \rangle = n(\beta B_0/R_0)x_e$. Differentiating Eq. 5 with respect to p , and averaging over the muon ensemble gives

$$\left\langle \frac{\delta\omega_a}{\omega_a} \right\rangle = -2\beta^2 n(1 - n) \left\langle \left(\frac{x_e}{R_0} \right)^2 \right\rangle \quad (21)$$

where $\langle x_e^2 \rangle$ is obtained from the fast rotation analysis. While the radial distribution uncertainty is based on data, it is checked against the simulation. Both methods agree on the mean-square width to a precision of 5 percent. This uncertainty is added in quadrature with the uncertainty in the mean muon radial position with respect to the electrostatic quadrupoles $\delta R = \pm 0.5$ mm (± 0.01 ppm in a_μ), and with the uncertainty in the mean vertical position of the beam ± 1 mm (± 0.02 ppm in a_μ). As a quantitative example, the R01 electric-field correction to the precession frequency for the low- n subperiod is $(+0.47 \pm 0.05)$ ppm.

The pitch correction [30] accounts for the fact that vertical betatron motion decreases slightly the magnetic field felt by the stored muons in their rest frame. When the orbit is inclined at angle ψ to the horizontal, to sufficient accuracy ω_a is reduced by the factor $(1 - \frac{1}{2}\psi^2)$. If ψ_m is the angular amplitude of the vertical oscillation, the average over the ensemble of muons is $(1 - \frac{1}{4}\langle\psi_m^2\rangle)$. Here $\langle\psi_m^2\rangle = n\langle y^2\rangle/R_0^2$, where $\langle y^2 \rangle$ is the mean-squared vertical spread of the stored muons, which was measured by the traceback system, confirming results from the tracking simulation.

The correction to the measured ω_a due to vertical betatron oscillations is calculated for each n value setting. The systematic error is estimated as the difference between the correction calculated from the simulated and measured muon distributions (± 0.03 ppm) added in quadrature with the uncertainty in the mean muon radial position with respect to the electrostatic quadrupoles and the uncertainty in the mean vertical position of the beam.

For the R01 low- n sub-period, the correction is $(+0.27\pm 0.04)$ ppm.

A tracking program, simulating the muon spin precession in the storage ring—including the correct azimuthal quadrupole electric field, confirmed the validity of the analytic electric-field and pitch corrections. The equations given in Ref. [31] were used for the orbit and the spin motion. The validity of the electric-field and pitch-correction expressions are verified to 0.01 ppm in a_μ .

IV. DATA ANALYSIS

The calculation of a_μ requires the determination of the muon spin precession frequency, ω_a , and the average magnetic field seen by the muons, $\tilde{\omega}_p$. “Precession” and “field” data are recorded separately and analyzed independently by different groups in the collaboration. To prevent bias, each analyzer adds a secret offset to any frequency result presented publicly. When *all* the analyses of a given type—precession or field—are deemed internally consistent, the individual offsets are replaced by a common offset, to facilitate comparisons between different analyses. Only when all the analyses of each type are in agreement, and all systematic investigations finished, are the final offsets removed. Then a_μ is calculated from the true ω_a and $\tilde{\omega}_p$ results.

Two independent determinations of $\tilde{\omega}_p$ were made per running period. The NMR tools, described in Section II G, were used to provide the measurements as follows. Every 3-4 days, the field distribution in the storage volume is mapped by the NMR trolley. The time-dependence of the field is measured using the fixed-probe NMR system, which samples and records the magnetic field around the ring at approximately 0.1 Hz. Special calibration measurements are made before and after the data-taking periods at a fixed location inside the ring vacuum, where the field uniformity is especially good, to transfer the absolute calibration to the plunging probe and to the trolley probes. The calibration of trolley probes against the plunging probe demonstrates the stability of the trolley probe over the run period.

Four or five independent determinations of ω_a were made per running period. The principal data are the waveform digitizer records for each calorimeter station, from which decay electron times and energies are extracted. Events above an energy threshold are included in electron time distributions, such as the one shown in Fig. 2. The precession frequency

is extracted from a χ^2 minimization fitting procedure, where the fit function is based on Eq. 10, plus small perturbations from known physical effects.

The data-taking was organized in short (≈ 45 min) runs, during which the macroscopic conditions remained stable. A database was used to mark each run for special characteristics, such as laser calibration, field index and scraping time, special radial magnetic-field settings and other systematic tests. Approximately 1000 - 1300 good production runs remain per data-taking period after complete commissioning of the apparatus and excluding special runs for systematic studies. The vast majority of runs took place under ideal operating conditions. However, whole runs were removed if they failed a Kolmogorov-Smirnov test that was designed to compare each run against a standard data set; this test was aimed specifically to search for hardware problems that may have gone unnoticed. One special virtue of the method is that it does not rely on any information associated with the precession frequency. Runs were also discarded if the power supplies for the surface correction coils were not stable. Before being included in the final data sample, each fill within a run was checked against a set of quality standards: injection bunch intensity and shape must not vary substantially; no AGS extraction misfires; no quadrupole sparks or missing quadrupole traces from the data stream; no kicker misfirings; no detector electronics malfunctions; no memory overflows in the onboard electronics; and, no missing marker pulses.

A. Determination of ω_p and $\tilde{\omega}_p$

Two independent analyses of the magnetic field were made for each of the data-taking periods. The methodology was similar for all analyses. Consistent results were obtained for all run periods. The description below focuses on one of the analyses for the R00 data-taking period.

1. Absolute calibration probe

The determination of a_μ requires a measurement of the free-proton precession frequency, $\omega_p (= 2\pi f_p)$, in the storage ring magnetic field. However, the free induction decay (FID) signals observed with the trolley NMR probes were not those from free protons, but protons in water with a CuSO_4 additive that shortened the relaxation time of the FID signal. In

addition the field is different from that in which the muons were precessing, being perturbed by the magnetization of the materials in the probe and trolley construction. To determine ω_p required an absolute calibration probe to relate the trolley probe FID precession frequencies to that of a free proton in an unperturbed field.

The absolute calibration probe [32] measured the precession frequency of protons in a spherical water sample. It is constructed to tight mechanical tolerances, using materials of low magnetic susceptibility. The perturbation of the probe materials on the field at the spherical water sample was minimized, measured, and corrected for. This allowed the storage ring magnetic field to be expressed in terms of the precession frequency of protons in a spherical water sample $\omega_p(\text{sph}, \text{H}_2\text{O}, T)$ at temperature T .

A precession frequency measured with the absolute calibration probe was then related to the spin precession frequency of a free proton through [33]:

$$\omega_p(\text{sph}, \text{H}_2\text{O}, T) = [1 - \sigma(\text{H}_2\text{O}, T)] \omega_p(\text{free}). \quad (22)$$

Here $\sigma(\text{H}_2\text{O}, T)$ accounts for the internal diamagnetic shielding of a proton in a water molecule, determined from [23]:

$$\begin{aligned} \sigma(\text{H}_2\text{O}, 307.85 \text{ K}) &= 1 - \frac{g_p(\text{H}_2\text{O}, 307.85 \text{ K})}{g_J(\text{H})} \frac{g_J(\text{H})}{g_p(\text{H})} \frac{g_p(\text{H})}{g_p(\text{free})} \\ &= 25.790(14) \times 10^{-6}. \end{aligned}$$

The ratio of the g factor of the proton in water to that of the electron in ground-state atomic hydrogen was measured to 10 ppb [23]. The ratio of the electron to proton g factors in hydrogen is known to 9 ppb [34], and the bound-state corrections relating the g factor of a free proton to one in hydrogen were calculated in [35, 36]. We also corrected for the measured temperature dependence of the shielding constant, $d\sigma(\text{H}_2\text{O}, T)/dT = 10.36(30) \times 10^{-9}/\text{K}$ [37].

The overall accuracy of the free-proton precession frequency determined with the absolute calibration probe was estimated to be 0.05 ppm. This same probe was used in the muonium experiment in which μ_μ/μ_p has been determined [12]. Since the magnets were different for the two experiments, the perturbations of the absolute calibration probe materials on the field at the spherical water sample were different. The change in field is of the order of a few ppb, and is caused by magnetic images of the probe in the g-2 magnet pole pieces.

A cross-check on the accuracy of the calibration probe comes from measurements made in the muonium experiment where the ground state hyperfine interval $\Delta\nu_{\text{HFS}}$ was measured

to 12 ppb, a result that is independent of errors in the calibration probe. Because the theoretical prediction for the hyperfine interval, $\Delta\nu_{\text{HFS,th}}$, depends on μ_{μ}/μ_p as a parameter, by equating $\Delta\nu_{\text{HFS}}$ and $\Delta\nu_{\text{HFS,th}}$, we can determine μ_{μ}/μ_p to 30 ppb [12, 33, 38]. The value extracted agrees with μ_{μ}/μ_p , determined to 120 ppb from the measurement of two Zeeman hyperfine transitions in muonium in a strong magnetic field [12]. The latter measurement of the magnetic moment ratio is strongly dependent on the magnetic field measured using the absolute calibration probe, and it is only weakly dependent on $\Delta\nu_{\text{HFS,exp}}$. If we assume the theoretical value is correct, the consistency of the two determinations of μ_{μ}/μ_p suggests the absolute calibration probe is accurate to better than 120 ppb.

2. Trolley probe and plunging probe relative calibration

Before and after each data-taking period, the absolute probe was used to calibrate the plunging probe, the trolley center probe, and several of the other trolley probes. The procedure was carried out at carefully shimmed locations in the storage ring having good field homogeneity. Measurements from the 17 trolley probes, taken at such an azimuthal location, were then compared to those from the plunging probe and hence with respect to each other. The errors which arise in the comparison are caused both by the uncertainty in the relative positioning of the trolley probe and the plunging probe, and on the local field inhomogeneity. The position of the trolley probes is fixed with respect to the frame that holds them and to the rail system on which the trolley rides. The vertical and radial positions of the trolley probes with respect to the plunging probe are determined by applying a sextupole field and comparing the change of field measured by the two. The error caused by the relative position uncertainty is minimized by shimming the calibration field to be as homogeneous as possible. In the vertical and radial directions, the field inhomogeneity is less than 0.02 ppm/mm, as shown in Fig. 25, and the full multipole components at the calibration position are given in Table IX, along with the multipole content of the full magnetic field averaged over azimuth. For the estimated 1 mm position uncertainty, the uncertainty on the relative calibration is less than 0.02 ppm.

Field variation along the azimuthal direction also leads to calibration uncertainties because the precise azimuthal location of the trolley probe's active volume is not known, *a priori*, to better than a few mm. Azimuthal field gradients were created at the calibration

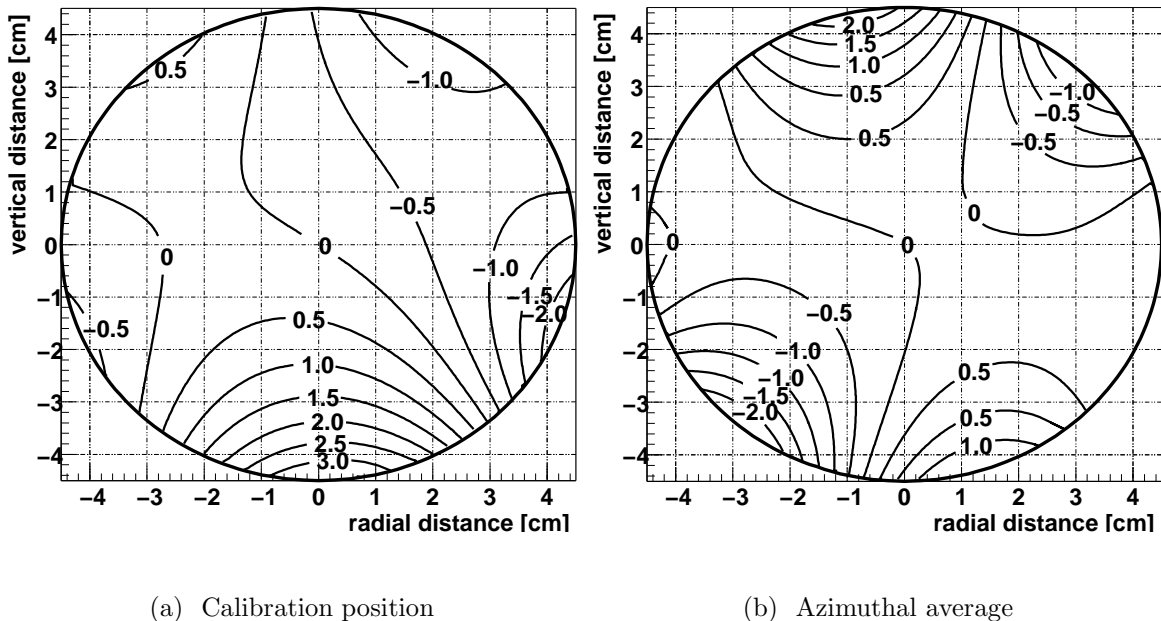

FIG. 25: Homogeneity of the field at the (a) calibration position and (b) in the azimuthal average for one trolley run during the R00 period. The contour lines correspond to 0.5 ppm field differences between adjacent pairs.

location by powering correcting coils on the surface of nearby magnet poles. The gradients were measured with the trolley positioned at various locations, typically 10 mm apart in azimuth. The trolley measurements and the shift in field measured with the plunging probe determine the azimuthal positioning of the active volume within the trolley probes with respect to the plunging probe. The corresponding contribution to the relative calibration of the trolley probes amounts to 0.03 ppm.

The calibration of the NMR probes may vary with the measured NMR frequency, since the frequency is determined by counting zero crossings in a signal with a decaying baseline. Other factors, such as the temperature and power supply voltage, may have an effect as well. The effects were studied and an uncertainty contribution of 0.05 ppm in the field measurement was derived.

The absolute calibration of the trolley probes was made with the storage ring at atmospheric pressure while the measurements used in the analysis were made with the ring under vacuum. The paramagnetism of O_2 in the air-filled trolley creates a small shift in the measured field, which depends on the positions of the probes within the trolley. The size of the

shift was estimated by taking a tube of the same size and shape as the trolley, containing an NMR probe, and filling the tube alternately with pure O₂ and N₂. The resulting correction is 0.037 ppm.

3. Measurement of azimuthal field average with trolley probes

The trolley is pulled by a cable around the inside of the storage ring to measure the magnetic field integral in the same volume where the muons are stored. Figure 26 shows the field measured by the center trolley probe for a typical measurement in the R01 period. The trolley is pulled clockwise or counterclockwise through the storage ring in about two hours, and the magnetic field is measured at about 6000 locations. Trolley measurements were made two to three times per week at varying times during the day or night. The azimuthal trolley positions were determined from the perturbations to the fixed-probe readings when the trolley passes, and from the readings of a pair of potentiometers whose resistances were set by the drums that wind and unwind the trolley cables. In the final R01 running period, the use of an optical encoder system further improved the trolley position measurement.

The trolley probe measurements are averaged over azimuth and a multipole expansion including terms up to 4th order for a two-dimensional field without an azimuthal component

TABLE IX: Multipoles at the outer edge of the storage volume (radius = 45 mm). The left-hand set are for the azimuthal position where the plunging and calibration probes are inserted. The right-hand set are the multipoles obtained by averaging over azimuth for a representative trolley run during the R00 period.

Multipole [ppm]	Calibration Position		Azimuthal Averaged	
	Normal	Skew	Normal	Skew
Quadrupole	-0.71	-1.04	0.24	0.29
Sextupole	-1.24	-0.29	-0.53	-1.06
Octupole	-0.03	1.06	-0.10	-0.15
Decupole	0.27	0.40	0.82	0.54

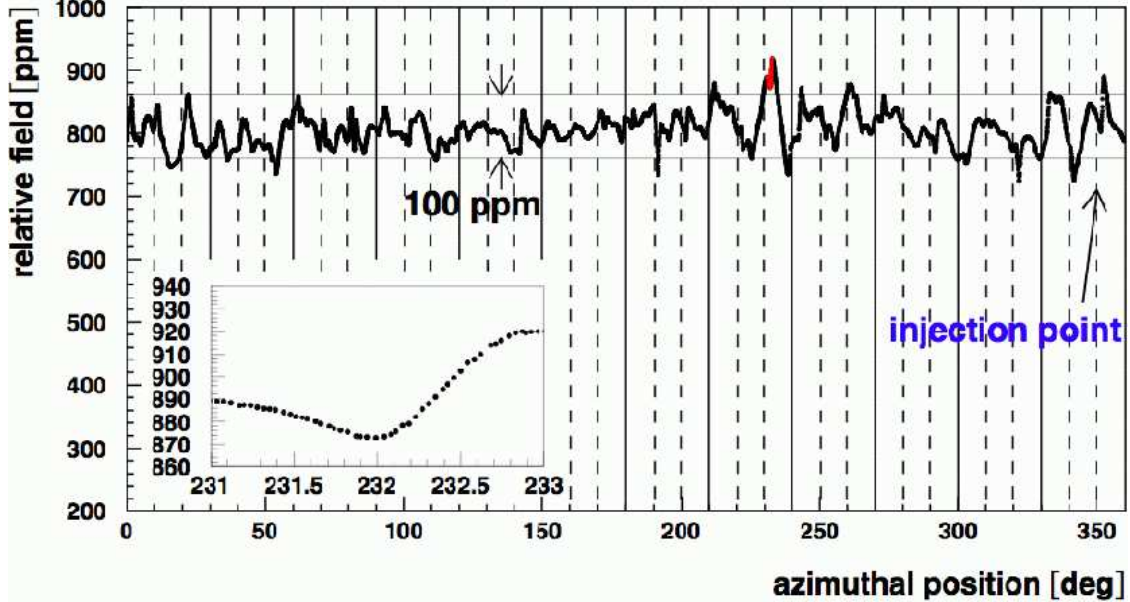

FIG. 26: The NMR frequency measured with the center trolley probe relative to a 61.74 MHz reference versus the azimuthal position in the storage ring for one of the measurements with the field trolley during the R01 period. The continuous vertical lines mark the boundaries of the 12 yoke pieces of the storage ring. The dashed vertical lines indicate the boundaries of the pole pieces. The inset focuses in on the measurements over an interval of two degrees. The point-to-point scatter in the measurements is seen to be small.

is made following

$$B(r, \theta) = B_0 + \sum_{n=1}^4 \left(\frac{r}{r_0} \right)^n [a_n \cos(n\theta) + b_n \sin(n\theta)]. \quad (23)$$

Here x and y are the radial and vertical directions and the corresponding cylindrical coordinates are (r, θ) with $r = 0$ at the center of the storage region and $\theta = 0$ defined to point radially outward. The multipoles a_i (normal) and b_i (skew) are normalized at $r_0 = 45$ mm; the contour plot obtained from one trolley run is shown in Fig. 25(b), which corresponds to the multipole content in the right-hand list of Table IX.

The trolley measures the magnetic field in the muon storage region up to a radius of 35 mm. The magnetic field beyond 35 mm radius is obtained by extrapolating the measured moments up to and including the decupoles. Data obtained in 1998 with a special shimming trolley—having 25 NMR probes positioned to measure the field up to 45 mm radius—determined the field in the outer region and the higher multipoles. The shimming trolley

ran along the pole pieces and could only be used with the vacuum chamber removed. The multipole expansions of the shimming trolley data at six azimuthal positions, both at the pole edge and at the pole center, all give less than 8 ppm at 45 mm for multipoles higher than the decupoles. By assuming an 8 ppm multipole at 45 mm and by multiplying its radial dependence by the falling muon distribution, a maximum uncertainty of 0.03 ppm is implied on the average field seen by the muons, a negligibly small error.

The overall position uncertainty of the trolley, combined with the field inhomogeneity, contribute to the error on the average field B_0 . The short-range jitter in azimuth is not correlated to the field inhomogeneity and its effect, averaged out over many trolley runs, is estimated to be smaller than 0.005 ppm. By contrast, the long-range position error can be a systematic deviation. Combining this uncertainty with the field inhomogeneity gives a 0.10 ppm uncertainty in the worst case for runs prior to 2001. Improved longitudinal position measurements reduced this uncertainty to 0.05 ppm for 2001. Both the normal and skew quadrupoles vary from -0.5 to +0.5 ppm/mm over the azimuth. The vertical and radial position of the trolley, over most parts of the ring are constrained within ± 0.5 mm with respect to the center of the storage region. The transverse position uncertainty should not be correlated with the multipoles and hence there is no effect on average field due to vertical and horizontal position uncertainties. There are some gaps, about 100 mm in total, where the position uncertainty could be as large as 3 mm and where the field inhomogeneity could be as large as 1.3 ppm/mm. The contribution to the average field uncertainty from such an extreme case is 0.01 ppm, which is negligible. Reverse direction trolley runs are also used in the analysis, which are important to confirm the forward direction runs.

The NMR measurements provide only absolute field magnitudes, $|\vec{B}| = \sqrt{B_x^2 + B_y^2 + B_z^2}$, where B_x , B_y and B_z are the radial, vertical and longitudinal components, respectively. The quantity $|\vec{B}|$ is used, rather than B_y to calculate a_μ . This introduces an error

$$|\vec{B}| - |B_y| = \sqrt{B_x^2 + B_y^2 + B_z^2} - |B_y| \simeq \frac{B_x^2 + B_z^2}{2|B_y|}, \quad \text{for } B_x \ll B_y, \quad B_z \ll B_y. \quad (24)$$

The radial field B_x is measured [39] in some locations in the storage ring; B_y and B_z are both estimated using Maxwell's equations. The difference between B_y and $|\vec{B}|$ is less than 0.01 ppm.

4. *Field tracking with the fixed probes*

The fixed probes are used to track the magnetic field during data taking—the time between the direct measurements made by the NMR trolley. Of the 378 fixed probes, which are placed in grooves in the walls of the vacuum chamber, about half are useful for the analysis. Some probes are simply too noisy. Other probes, located in regions where the magnetic field gradients are large, have very short FID times and therefore make measurements of limited precision. Still other probes failed during the data-taking periods because of mechanical and cable defects. The probes used in the analysis were given a weight related to the region over which they are sensitive. For example, the field measurements of a fixed probe at the junction of magnet pole pieces are sensitive to a more restricted region compared to a probe located at the center of the poles. Therefore, a higher weight in calculating the field average from the fixed probes is used for probes near the pole centers than to probes near the pole edges. The values for the weights, about 0.3 and 0.7, were chosen so as to optimize the agreement between the field average determined with the trolley probes and that determined with the fixed probes. The weights were constant for all data-taking periods.

The differences between the average dipole field from the trolley measurements and the weighted average field from the fixed probes, made *during* the trolley measurements of the R01 running period, are shown in Fig. 27. Because of magnet ramping or changes in the surface coil currents, the comparison between pairs of adjacent points has meaning only when trolley measurements were made during the same power cycle (the power cycles are indicated by the vertical divisions). The rms distribution of those differences is 0.10 ppm. The average magnetic field for the R00 and R01 periods is shown in Fig. 28. The relatively flat distribution is from the R01 period, where the feedback system kept the field stable at the few ppm level or better. The large deviations near run 600 of the R00 data-taking period were caused by a fault in the feedback system, but even then, the average field was measured with sufficient accuracy.

5. *Average of the field over muon distribution and time*

The stray magnetic field from the pulsed AGS magnets and from the eddy currents caused by the kicker magnet has an effect on the storage ring magnetic field. Fortunately, the field

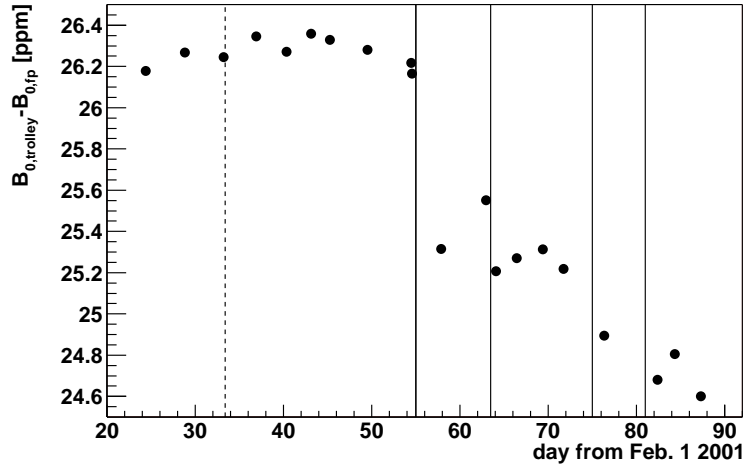

FIG. 27: The difference between the average field from the trolley measurements and the one determined using a subset of the fixed probes versus time. The solid vertical lines indicate times when the difference is expected to change because the magnet power is cycled. The vertical dashed line shows when the inflector was powered on.

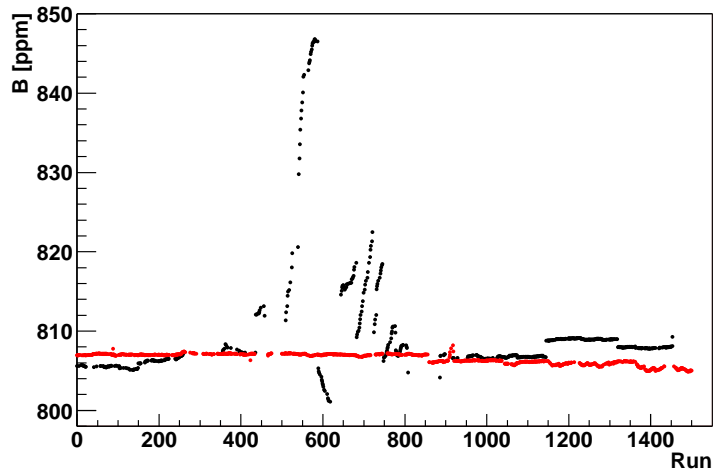

FIG. 28: The average magnetic field versus run number (relative to the start of good data) for the R00 and R01 periods. The relatively flat distribution is from the R01 period, where the feedback system kept the field stable at the few ppm level or better. In R00, large deviations are seen owing to a temporary fault in the feedback system.

measured by the fixed NMR probes is a time average, which is largely insensitive to such transient effects. The field from the AGS magnets is determined by plotting the fixed NMR probe readings obtained during the 2×10^5 AGS cycles modulo the AGS period of 3 s. Its effect is less than 0.01 ppm. The effect on the magnetic field in the storage region from the kicker magnet eddy currents was measured in a special setup of the prototype kicker magnet [20], as this transient magnetic field is largely shielded from the fixed NMR probes by the aluminum vacuum chamber walls. At 30 μ s after injection, when the ω_a fits typically begin, the influence of stray magnetic fields on the average magnetic field seen by the muons is 0.02 ppm [20].

A multipole expansion is used to express the average field felt by the circulating muons. The azimuthally averaged magnetic field is written

$$B(r, \theta) = \sum_{n=1}^{\infty} r^n (c_n \cos n\theta + s_n \sin n\theta) \quad (25)$$

where the coefficients c_n and s_n are the normal and skew moments, respectively. The muon distribution moments I_n , J_n are defined:

$$\begin{aligned} I_0 &= \int_0^{r_0} \int_0^{2\pi} M(r, \theta) r dr d\theta \\ I_n &= \int_0^{r_0} \int_0^{2\pi} r^n M(r, \theta) \cos n\theta r dr d\theta \\ J_n &= \int_0^{r_0} \int_0^{2\pi} r^n M(r, \theta) \sin n\theta r dr d\theta. \end{aligned}$$

The average field seen by the muons is then given by

$$\bar{B} = c_0 + \frac{1}{I_0} \sum_{n=1}^{\infty} (c_n I_n + s_n J_n).$$

For the circular storage ring aperture, only the first few multipoles of the muon distribution are significant. Of those, the normal moments (I_n) tend to be more important, except for the R00 period, when the muon beam was approximately 2 mm above the mid-plane for much of the early data taking. The radial mean I_1 is deduced from the fast-rotation analysis. The higher moments require the instantaneous radial distributions measured by the traceback system, the most important of which is the radial RMS width ≈ 15 mm, consistent with the results of the full tracking simulation.

TABLE X: Weighting of the magnetic field $B(x, y)$ from a representative NMR trolley run during the R00 period over the muon distribution $M(x, y)$ for the sextupole through decupole components.

Multipole	$M(x, y)$	$B(x, y)$ [ppm]	Product [ppb]
Sextupole	0.02	-0.53	-11
Octupole	-0.003	0.10	-0.3
Decupole	0.005	0.82	4.0

Combining the muon distribution and the field moments yields only very small corrections to the lowest-order terms. In the R00 running period, the beam radial centroid was 2.3 ± 1.0 mm larger than the nominal aperture center and the normal quadrupole moment of the magnetic field at the aperture of the muon storage region was 0.06 ppm of 1.45 T. Specifically, $B_r(r, \theta) = f(r) \cos(\theta)$ and $B_y(r, \theta) = f(r) \sin(\theta)$, where $f(r) = (0.06 \text{ ppm}) \cdot (1.45 \text{ T}) \cdot (r/45 \text{ mm})$. Therefore, the average magnetic field seen by the muons is $0.06 \text{ ppm} \times (2.3 \text{ mm}/45 \text{ mm}) = 0.003 \text{ ppm}$ higher than the field at the aperture center. Because the beam position is not known on a run by run basis, the rms of the normal quadrupole distribution is used to estimate the field error: 0.022 ppm. In the vertical direction, the skew quadrupole from all trolley runs is -0.11 ppm with an rms of 0.27 ppm. However, even when the beam was 2 mm high during R00, the correction was negligible. The associated field error was taken to be $0.27 \text{ ppm} \times (2 \text{ mm}/45 \text{ mm}) = 0.012 \text{ ppm}$.

The weighting of the sextupole and higher normal magnetic field multipoles over the simulated muon distribution is shown in Table X. The results were checked with full particle tracking and the complete magnetic field map $B(x, y, s)$. All the sextupole and higher skew multipoles of the muon distribution are less than 10^{-3} . No correction was made for moments higher than the quadrupole. Instead, those values were incorporated into the systematic error. The total systematic error in weighting the magnetic field over the muon distribution is $\pm 0.03 \text{ ppm}$. To compute the average field seen by the muons, the average magnetic field is calculated for each run, and then averaged over all runs with a weight corresponding to the number of decay electrons in each run.

TABLE XI: Systematic errors for the magnetic field for the different run periods. †Higher multipoles, trolley temperature and its power supply voltage response, and eddy currents from the kicker.

Source of errors	R99	R00	R01
	[ppm]	[ppm]	[ppm]
Absolute calibration of standard probe	0.05	0.05	0.05
Calibration of trolley probes	0.20	0.15	0.09
Trolley measurements of B_0	0.10	0.10	0.05
Interpolation with fixed probes	0.15	0.10	0.07
Uncertainty from muon distribution	0.12	0.03	0.03
Inflector fringe field uncertainty	0.20	–	–
Others †	0.15	0.10	0.10
Total systematic error on ω_p	0.4	0.24	0.17
Muon-averaged field [Hz]: $\tilde{\omega}_p/2\pi$	61 791 256	61 791 595	61 791 400

6. Results and systematic errors

The weighted average field and systematic uncertainties for the three running periods used in the final combined result are shown in Table XI. A defect in the shield of the superconducting inflector resulted in imperfect shielding of the inflector field for the R99 period. Over an azimuthal angle of $\sim 1^\circ$ degree, the residual fringe field lowered the magnetic field by about 600 (3000) ppm at the center (edge) of the storage aperture. This made a separate measurement of the field necessary in this region and led to an additional uncertainty of 0.2 ppm. The inflector was replaced between the R99 and R00 periods.

B. Analysis of ω_a

The anomalous muon spin precession at frequency ω_a leads to a corresponding modulation in the number of electrons striking the detectors. A general form of the electron time spectrum for events having energy E is

$$N(E, t) = N_o(E, t)e^{-t/\gamma\tau_\mu}[1 - A(E, t) \cos(\omega_a t + \phi(E, t))], \quad (26)$$

where explicit energy and time dependencies for the normalization, asymmetry and phase are included. The replacement $E \rightarrow E_{th}$ is a convenient simplification of Eq. 26 when the spectra include all events above energy threshold E_{th} . An example of a histogram of the decay electron data from the R01 period was presented in Fig. 2. The anomalous spin precession frequency ω_a , having period $\tau_a = 2\pi/\omega_a \approx 4.365 \mu\text{s}$, is the prominent feature. The asymmetry $A(E_{th}, t)$ is ≈ 0.4 , as the threshold energy in this histogram is 1.8 GeV. The time-dilated muon lifetime is $\gamma\tau_\mu \approx 64.4 \mu\text{s}$.

The only kinematic cut applied in the ω_a analysis is the energy of a given event; it is therefore important to establish the dependence of the fit parameters on energy. For example, $N(E)$ (integrated over all decay times, t) is a gradually falling distribution in the ideal case, having an endpoint at 3.1 GeV (see Fig. 1b). Because of the size of the detectors and their placement around the storage ring, their acceptance is a strong function of energy. At 1.8 GeV, it is approximately 65 percent and the acceptance drops with decreasing energy because low-energy electrons, having small bending radii, can curl between detector stations. At higher energies, the acceptance rises slowly until, close to 3.1 GeV, the bending radii are nearly equal to the storage ring radius. These electrons strike the outer radial edge of a calorimeter, where they are poorly measured because of incomplete shower containment. Obstacles inside the storage aperture that are in the path of decay electrons (quadrupole and kicker plates, the vacuum chamber wall) can initiate partial showering, with the result that a higher-energy electron appears in the detectors as a lower-energy event. The observed energy spectrum is shown in the inset to Fig. 32. In the ideal case, the asymmetry A is also a monotonically increasing function of energy, starting at -0.2 for $E = 0$ and rising to +1 at 3.1 GeV. It crosses 0 at approximately 1.1 GeV. Because of upstream showering and finite energy resolution, the measured asymmetry differs from expectation.

The phase $\phi(E)$ represents the average muon spin angle as a function of energy at $t = 0$. It is maximally correlated to ω_a in the fitting procedure. In the ideal case, the energy dependence is trivial. The phase angle is constant for E above the nominal threshold. The actual shape is explained by two geometrical considerations, both of which depend on energy. The time assigned to a decay electron corresponds to the *arrival* at the detector, not to the *decay*. High-energy electrons are assigned times later after the decay than low-energy electrons because their average path length to the detector is longer. In addition, the detector acceptance is slightly greater when the electron decay angle is inward—toward the center of

the storage ring—compared to when it is outward, and the magnitude of the difference scales with energy. A plot of phase versus energy, based on a tracking and detector simulation, is shown in Fig. 29. The energy dependences of N , A and ϕ do not, in principle, affect the anomalous precession frequency ω_a . Any superposition of decay electrons having a time variation given by Eq. 26, will be of the same form, having the same modulation frequency, ω_a . However, the time dependence of $\phi(E)$ is an important concern. For example, an energy-scale change as a function of time after injection is particularly dangerous because E_{th} is set at an energy where $d\phi/dE$ is relatively large (see inset to Fig. 29).

Considerable effort was invested in developing a physically motivated functional form that describes the electron decay spectrum. For example, the coherent betatron oscillation described in Sec. III C modulates N , A and ϕ with an amplitude and decay time that must be determined from the data. Once a suitable functional form is developed, the remaining task is to show that the frequencies extracted from the resulting fits are immune to a large number of possible systematic errors.

The ω_a analyses all rely on non-linear χ^2 minimization using a fitting function $F(t, \vec{\alpha})$, having a range of free parameters $\vec{\alpha}$ that depends on the specific fitting and data-preparation strategy of the analyzer. The reduced chi-squared, χ^2/dof ($\text{dof} \equiv \text{degree of freedom}$), is used to judge the goodness of fit with the condition that $\chi^2/\text{dof} = 1$ with a variance of $\sqrt{2/\text{dof}}$, a property of the χ^2 distribution. For the typically 4000 degrees of freedom in the fits described here, an acceptable reduced chi-squared is 1 ± 0.022 , which is minimized by varying the free parameters. In the limit of a large number of events in each bin (e.g., $N_k > 30$) the variance becomes Gaussian. The fit range in the different analyses is always truncated well before the number of counts in the last bin is fewer than this limit. In the sections that follow, we describe the data preparation and fitting procedures.

1. Data preparation and pulse-fitting procedure

Figure 30 depicts a schematic fill as recorded by the waveform digitizer for one calorimeter station near the inflector. Prior to injection, the calorimeters are gated off and a triangular-shaped marker pulse is conveyed to each WFD to establish correct phasing of the two independent 200 MHz digitizers. The calorimeters are gated on 2–27 μs after the muon bunch is injected. A time-dependent pedestal remains from the prompt hadronic flash. For detectors

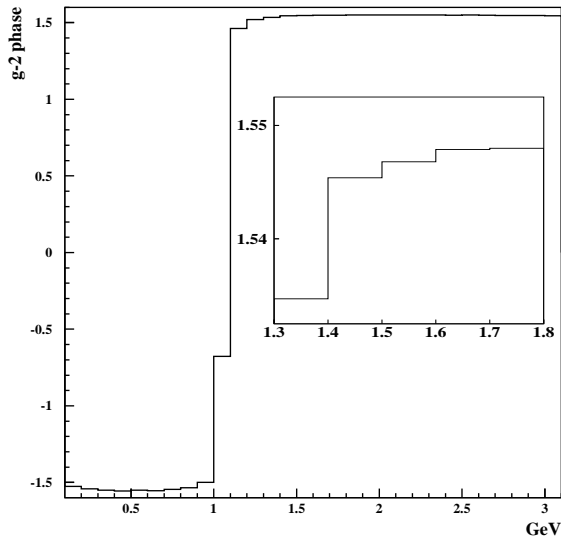

FIG. 29: Relative $(g - 2)$ phase versus energy from a tracking simulation. There is an abrupt shift by π radians at approximately 1.05 GeV. Inset: an expanded view of the phase plot from 1.3 to 1.8 GeV. The required gain stability with time is proportional to the slope of the curve at the energy threshold, as well as the differential asymmetry, $A(E_{th})$.

immediately downstream of the inflector, the pedestal can be well above the WFD trigger threshold for tens of microseconds, thus initiating a continuous digitization of the analog signals. The slowly decaying pedestal gives rise to an effective time change of the hardware threshold. True electron pulses ride on top of this background and must be identified and characterized as (E, t) pairs. The function of the pulse-finding algorithms is to identify such events within the roughly $700 \mu s$ measuring interval. This task is particularly challenging because the initial instantaneous rate of a few MHz implies a pileup rate above 1 percent. The rate falls by a factor of 10^4 over the measurement interval. Because background and electron pileup can introduce a time dependence in the average phase, they can also bias the measurement of ω_a .

The data are reconstructed by two different programs, `g20ff` and `G2Too`. Their pulse-processing algorithms are conceptually similar but the programs share no code. The two algorithms were developed concurrently and the results obtained from the two were compared. A Monte Carlo waveform generator was used to check that each was immune to the

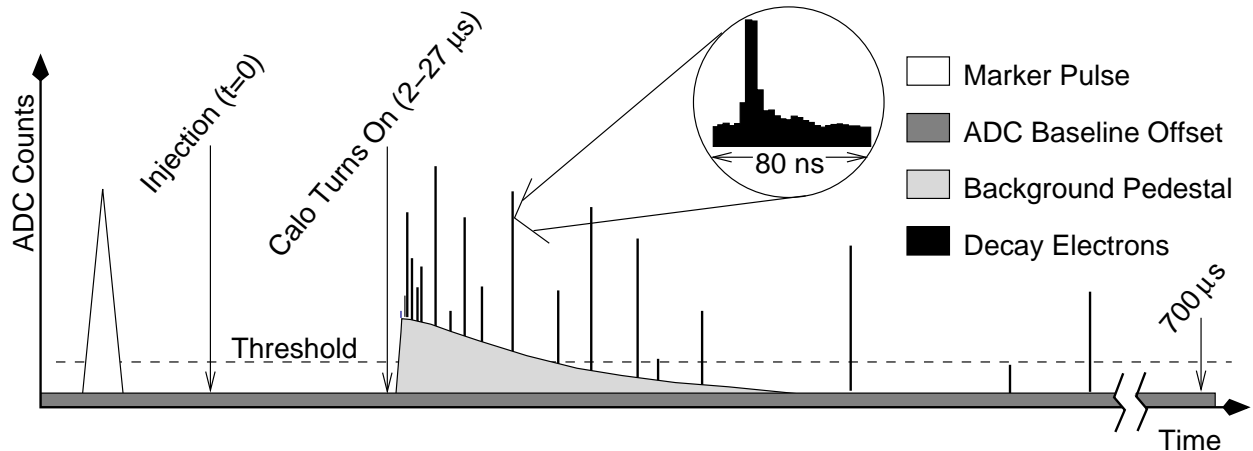

FIG. 30: Schematic representation of a WFD record obtained from a single calorimeter in one fill of the storage ring. The dark grey flat band represents an internal baseline added in hardware to prevent underflows. The open triangle marker pulse is inserted externally to establish the phase relation between the digitizers. The light grey decaying pedestal corresponds to a flash-induced background in the calorimeters. The narrow spikes, see expansion, represent the individual electron pulses of interest.

difficulties outlined above. The fraction of pulses that are found by only one of the two algorithms is small. Slightly different fill-acceptance criteria, together with intrinsic differences in the time and energy resolution of each method, lead to a 1–2 percent difference in the reconstructed events. This difference is accounted for in the comparison of ω_a results because it affects the statistical fluctuations.

The pulse-processing algorithm uses a standard pulse shape—determined independently for each calorimeter—as a template to extract the time and energy of the electron signals from the raw waveform samples. These shapes are largely independent of electron energy, which is proportional to the signal amplitude. The algorithm finds this amplitude, along with the time of the true maximum and the pedestal.

The average pulse shapes are built from sample pulses taken at times long after injection, when the pedestal is constant, and background and pileup are small. The sample pulses are aligned with respect to the time of the true maximum, t_m . A pseudotime is defined as

$$\tau = (2.5 \text{ ns})[i_{max} + (2/\pi) \tan^{-1} x_p], \quad (27)$$

where

$$x_p = \frac{S_{i_{max}} - S_{i_{max}-1}}{S_{i_{max}} - S_{i_{max}+1}},$$

and i_{max} is the index of the maximum sample and S_i is the value of the i th sample. Here x_p is a measure of where the samples lie with respect to t_m . If the maximum sample corresponds to the amplitude of the pulse, x_p is nearly 1, because the pulse is fairly symmetric near its peak. When the maximum sample moves earlier in time with respect to t_m , then x_p decreases, whereas x_p increases if it moves later. Note that x_p is a ratio of signal differences, in which the pedestal and scale cancel.

The true time of the pulse is a complicated function of the pseudotime. However, for any reasonable pulse shape, $t(\tau)$ is a monotonically increasing function. Since the distribution $p(t)$ of true times is uniform, modulo 5 ns, the measured distribution of pseudotimes is used to create a mapping between pseudotime and true time

$$t(\tau) = (5 \text{ ns}) \frac{\int_0^\tau p(\tau') d\tau'}{\int_0^{5 \text{ ns}} p(\tau') d\tau'} \quad (28)$$

to fix t_m for the pulse within the 5 ns time bin. The time bin is taken to be 5 ns rather than 2.5 ns because the pulse shapes are slightly different as viewed by the two flash ADCs of a given input channel. The pedestal is determined from the average signal far from the maximum.

Once the map between the pseudotime and true time has been established, the average pulse shape is readily determined. The pedestal-subtracted ADC samples of every pulse, time-aligned so that the true maximum sits at 0, are added to a finely binned time histogram. That histogram represents, by construction, the average pulse shape. As an example, the pulse shapes from the two independent WFD phases of one calorimeter are shown in Fig. 31. The shapes and amplitudes are slightly different, as noted above.

The main pulse processing routine fits each digitization interval using the template average pulse shape for each detector. First, the number of candidate pulses is determined by noting local peaks. The expression

$$D = \sum_{i \in \text{samples}} \left[S_i - P - \sum_{j \in \text{pulses}} A_j f_i(t_j) \right]^2 \quad (29)$$

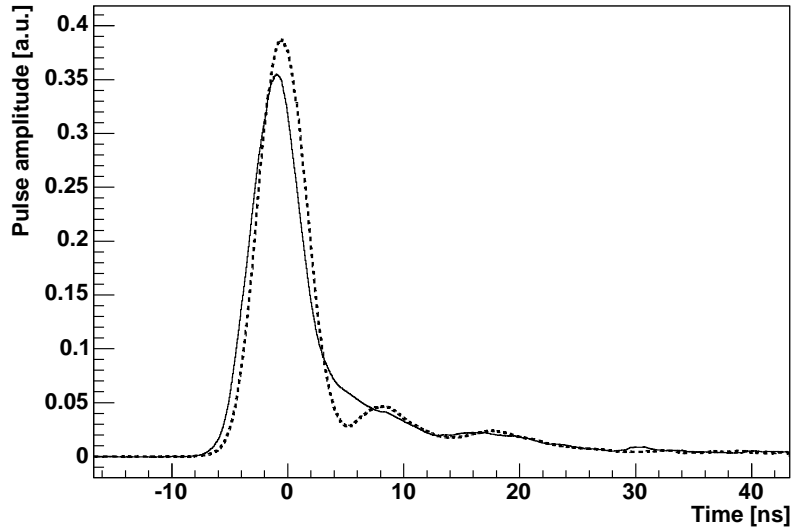

FIG. 31: Average pulse shapes for detector station 1. WFD phase 0 (dotted) has the more pronounced oscillatory behavior compared to phase 1 (solid).

is minimized. Here $f_i(t)$ is the average pulse shape and variables t_j , A_j and P are fit parameters, representing the times and amplitudes of each pulse and the pedestal. If the quality of the fit is inadequate, a new model that includes additional pulses is tested. For the typical digitization interval—having a single pulse—only a subset of fifteen 2.5 ns ADC samples centered on the assumed pulse is included in the fit. In practice, only the times t_j need to be included directly in the fit. The optimal A_j and P may be calculated analytically.

2. Energy calibration and stability

The calorimeter energy scale is determined for each detector from its measured energy spectrum; a typical spectrum is shown in Fig. 32. The indicated portion of the falling edge, in which the number of counts declines from 80 percent to 20 percent of its peak value, is fit by a straight line. The x -intercept of this line, the *endpoint*, corresponds to approximately 3.1 GeV.

The absolute energy scale needs to be known only approximately. However, it is critical to measure variations in the energy scale over the fill period. A time-changing gain—where the relevant time scale is tens of microseconds following the fit start time—can come from

true hardware drifts in the amplification system and from software reconstruction bias. Both effects are associated with the rate of events. To measure energy-scale stability, the mean energy $\bar{E}(t)$ of electrons above threshold as a function of time is constructed, suitably corrected for pileup (see next section) and binned in full $(g - 2)$ cycles to avoid the natural dependence of the average energy on the muon spin orientation. The gain stability function $G(t)$ is related to the average energy through

$$\frac{G(t) - G(\infty)}{G(\infty)} = f \cdot \left[\frac{\bar{E}(t) - \bar{E}(\infty)}{\bar{E}(\infty)} \right], \quad (30)$$

where f is a threshold-dependent constant, approximately equal to 2 for $E_{th} = 1.8$ GeV and $t = \infty$ refers to late in the fill. With the exception of a few detectors, $G(t)$ varies from unity by at most 0.2 percent for the fitting period. Typically, the electron time spectra are constructed applying $G(t)$ as a correction to each electron's energy.

To determine the sensitivity of ω_a on $G(t)$, electron time spectra are reconstructed where the applied $G(t)$ is varied by multiplying the optimal $G(t)$ by the multipliers $m_G = -1, 0, 1$ and 2. These spectra are then fit for ω_a and the slope $\delta\omega_a/\delta m_G$ is determined. Typically, the quoted result from an individual analysis is based on $m_G = 1$ and the gain systematic uncertainty is based on the change in ω_a if $G(t)$ is not applied. Because of differences in running conditions and fit start times, the gain systematic uncertainty differs by running period. The most complete studies of the gain systematic uncertainty were carried out for the R00 and R01 analyses, giving 0.13 and 0.12 ppm, respectively.

3. Correction for multi-particle pileup

Two low-energy electrons arriving close together in time are interpreted as one equivalent high-energy electron. Because low-energy electrons have a shorter drift time and their acceptance peaks at a different orientation of the muon spin, the $(g - 2)$ phase carried by these “pseudo-electrons” is different from a true high-energy electron. The phase difference, by itself, would not be of concern if the fraction of pileup pulses were constant over the measurement period. But, the pileup rate is proportional to $\sim e^{-2t/\gamma\tau}$, which has a time constant half that of the muon lifetime. The pileup fraction therefore changes in time, which can pull the $(g - 2)$ phase and thus bias ω_a . The general treatment of pileup in the analyses is to correct for pileup, then fit for ω_a .

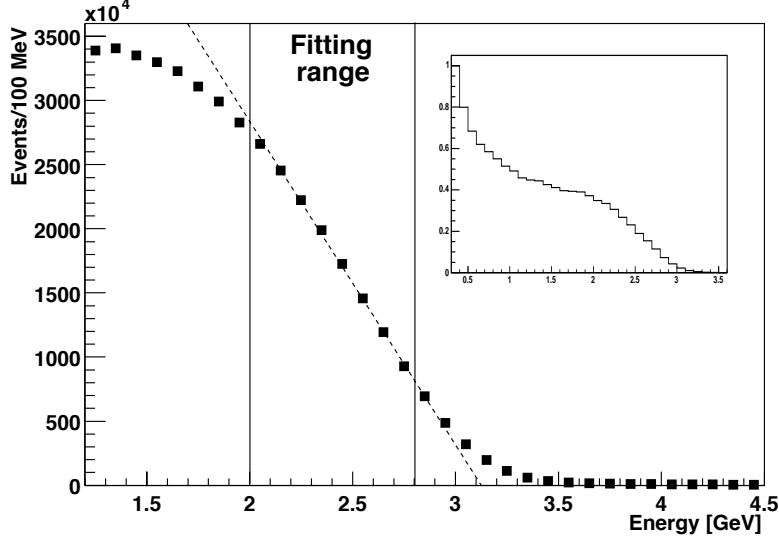

FIG. 32: Typical measured calorimeter energy distribution with an endpoint fit superimposed. The inset shows the full reconstructed energy spectrum from 0.3 to 3.5 GeV

Because the full raw waveforms are stored, most multi-particle pileup events are recognized by the fitting algorithms. When two pulses coexist on the same digitization interval and are separated by more than 5 ns, the pulse-finding algorithms can identify the individual pulses with nearly 100 percent reliability. The right panel of Fig. 15 shows two pulses separated by 7.5 ns. The fitting algorithms distinguish these pulses and correctly assign their times and energies.

Truly overlapped pulses cannot be separated, but they are accounted for *on average* by subtracting an artificially constructed pileup contribution from the spectra. Consider a digitization interval having a “trigger” pulse and a “shadow” pulse that trails the trigger pulse by a fixed time offset. The probability to find a pulse at time t is assumed to be the same as finding a similar pulse at time $t + \delta$ for $\delta \ll T_c$, the cyclotron period. The trigger pulse energy must exceed the ≈ 1 GeV hardware trigger threshold, but the shadow pulse can have any energy above the fitting minimum of approximately 0.25 GeV. The two-dimensional spectra $S_T(E, t)$ and $S_S(E, t)$ are obtained, where T and S represent trigger and shadow pulses, respectively. A “double” pulse having an energy equal to the sum of the trigger and shadow is created at a time determined by the average of the two pulses, weighted by their respective energies. Such events create the doubles distribution $D(E, t)$.

Finally, the pileup distribution is

$$P(E, t) = D(E, t) - S_T(E, t) - S_S(E, t). \quad (31)$$

The spectrum of counts can now be corrected for pileup by subtracting this distribution. In doing so, care must be taken to properly evaluate the errors because some of the events used to construct the pileup spectrum are part of the uncorrected spectrum already, depending on the energy cut. To sufficient precision, the uncertainty for a bin in the pileup-subtracted histogram at time t is described by $\sigma^2(t) = (1 + k \exp(-t/\gamma\tau_\mu)) F(t)$, where $F(t)$ is the functional form describing the pileup-free data and k is determined from the data itself.

A pileup-free spectrum is created from normalized difference spectra. Figure 33 illustrates the uncorrected energy distribution (upper curve), which extends well beyond the 3.1 GeV natural maximum because of pileup events. The artificially constructed pileup energy distribution is also shown (lower curve). It matches the raw distribution at the highest energies, confirming that pileup has been correctly constructed from the raw spectrum. Below 2.5 GeV, the constructed pileup spectrum is “negative” because two lower-energy electrons are removed and misinterpreted as a single higher-energy electron; in this figure, the absolute value is plotted.

The pileup systematic uncertainty falls into three categories: efficiency, phase, and unseen pileup. The pileup *efficiency* is established by creating a pileup event spectrum and adding it to the raw spectrum. A pileup multiplier, m_{pu} , is used to construct modified electron time distributions with varying pileup fractions. These spectra are fit to determine $\delta\omega_a/\delta m_{pu}$. Equality of the electron energy spectra early (high rate) and late (low rate) in the fill indicates that pileup is corrected; an uncertainty of 8 percent on this correction is assigned. The systematic uncertainty on ω_a from pileup subtraction efficiency is 0.036 ppm. The pileup *phase* reflects the error due to the uncertainty in the phase of the constructed pileup spectrum. Simulations determine the limits of the phase difference, and the amplitude of pileup subtraction, combined with the phase difference, yields an uncertainty in ω_a of 0.038 ppm. Finally, a 0.026 ppm uncertainty is assigned to the effect of those very-low-energy pulses, unnoticed by the pulse-finding algorithm, which are *not* included in the constructed pileup spectra. The combined pileup uncertainty on ω_a is 0.08 ppm, where the efficiency and phase uncertainties are correlated and add linearly and the unseen pileup uncertainty

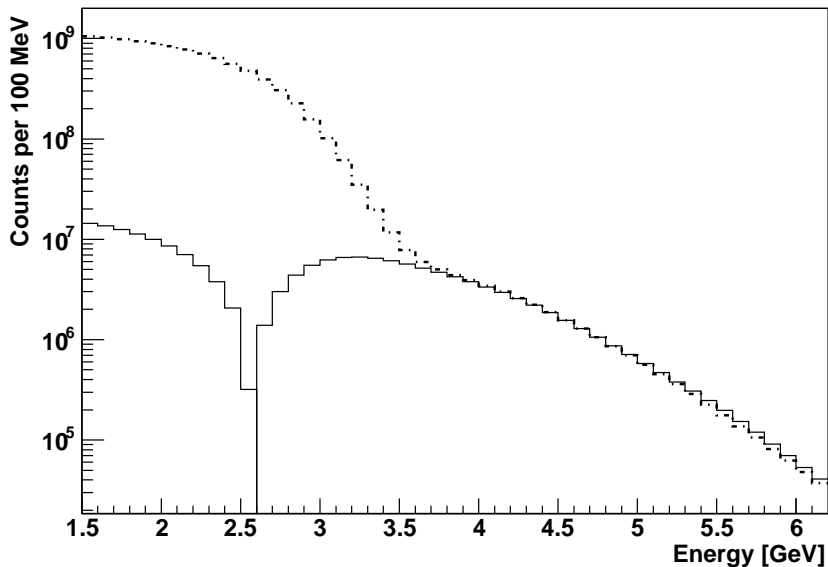

FIG. 33: Uncorrected energy spectrum, including pileup events (dotted, top curve) and artificial pileup reconstruction spectrum (solid, bottom curve). The energy distributions smoothly coincide above about 3.5 GeV, where only true pileup events can exist. Note, below 2.5 GeV, the pileup spectrum is negative. The absolute value is plotted.

is combined in quadrature.

4. Elimination of fast rotation

As described in Section III B, muons are injected into the storage ring in approximately Gaussian bunches with RMS widths of 25 ns. The momentum spread causes debunching with a time constant of approximately 20 μ s and the leading and trailing edges begin to overlap 5 μ s after injection. Approximately 30 μ s after injection—a typical fit start time—the underlying microstructure remains, appearing as a rapid modulation of the electron decay spectrum for a given detector. This fast-rotation signal is filtered from the decay spectra by adding a random fraction of the cyclotron period T_c to the reference time T_0 that marks the arrival of the bunch at the entrance to the storage ring, a procedure that reduces the fast-rotation modulation by a factor of about 500. Furthermore, if the calorimeter signals are aligned in time according to their azimuthal location and their decay spectra are

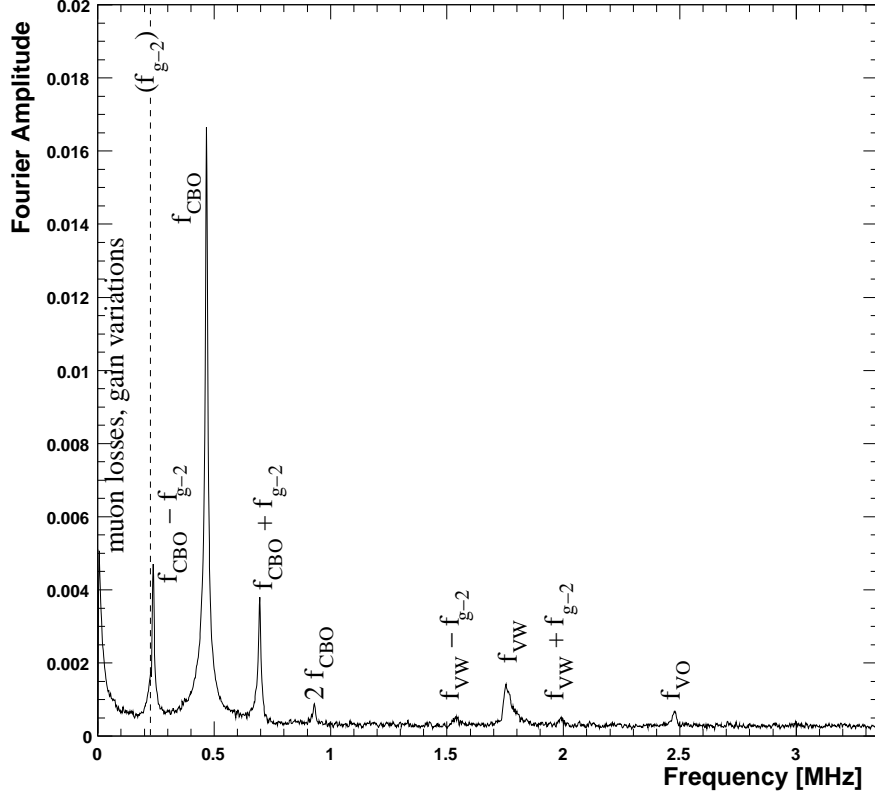

FIG. 34: The Fourier spectrum was obtained from residuals from a fit based on the five-parameter, ideal muon decay and spin precession expression. The horizontal coherent betatron oscillation (CBO) frequency at 466 kHz, its first harmonic, and the difference frequency between CBO and the $(g - 2)$ frequency are strong peaks. The vertical waist (VW) and CBO vertical oscillation (VO) produce smaller, but still significant, effects at high frequencies. The low-frequency rise stems from muon loss and gain distortions of the underlying decay exponential.

combined, the fast-rotation structure is reduced by an additional factor of 10.

In addition to the slow modulation caused by the $(g - 2)$ precession, the actual rate in a detector station varies significantly over a cyclotron period, from early times until the bunch structure has disappeared. The corresponding modulation of the pileup rate is handled automatically by the shadow pulse subtraction scheme.

5. Multi-parameter fitting

The electron decay spectra prepared as described above, fit with the naive five-parameter function in Eq. 10, results in a very poor χ^2/dof . Fourier analysis of the residuals reveals identifiable oscillatory features and slow changes to the overall spectral shape. Figure 34 shows the Fourier transform of the residuals of such a fit to the R01 data. While the fit removes ω_a from the residuals, strong peaks at the horizontal CBO frequency, its first harmonic, and at the sum and difference between the CBO and ω_a frequencies are evident. Additionally, small peaks associated with the vertical CBO (VO) and the vertical waist (VW) are seen at higher frequencies. The low-frequency rise is ascribed to distortions to the exponential envelope from muon loss and gain changes. These physical terms motivate development of a multi-parameter fitting function. A general form, which includes all known and relevant physical perturbations, and assumes an energy threshold E_{th} , can be written

$$N(t) = \frac{N_0}{\gamma\tau_\mu} e^{-t/\gamma\tau_\mu} \cdot \Lambda(t) \cdot V(t) \cdot B(t) \cdot C(t) \cdot [1 - A(t) \cos(\omega_a t + \phi(t))] \quad (32)$$

with

$$\Lambda(t) = 1 - A_{loss} \int_0^t L(t') e^{-t'/\gamma\tau_\mu} dt' \quad (33)$$

$$V(t) = 1 - e^{-t/\tau_{VW}} A_{VW} \cos(\omega_{VW} t + \phi_{VW}) \quad (34)$$

$$B(t) = 1 - A_{br} e^{-t/\tau_{br}} \quad (35)$$

$$C(t) = 1 - e^{-t/\tau_{cbo}} A_1 \cos(\omega_{cbo} t + \phi_1) \quad (36)$$

$$A(t) = A (1 - e^{-t/\tau_{cbo}} A_2 \cos(\omega_{cbo} t + \phi_2)) \quad (37)$$

$$\phi(t) = \phi_0 + e^{-t/\tau_{cbo}} A_3 \cos(\omega_{cbo} t + \phi_3). \quad (38)$$

While the additional terms are necessary to obtain an acceptable χ^2 , they are not strongly correlated to ω_a .

Equation 33 describes $\Lambda(t)$, which is derived from $L(t)$, which in turn is derived from the muon loss monitor data, as illustrated in Fig. 35. Muon loss introduces a slowly changing modification to the normal exponential decay. To determine the absolute rate of muon losses, the acceptance of the detection system must be established by the Monte Carlo simulation. With an estimated acceptance of a few percent, results from the fits indicate an approximate fractional loss rate of 10^{-3} per lifetime.

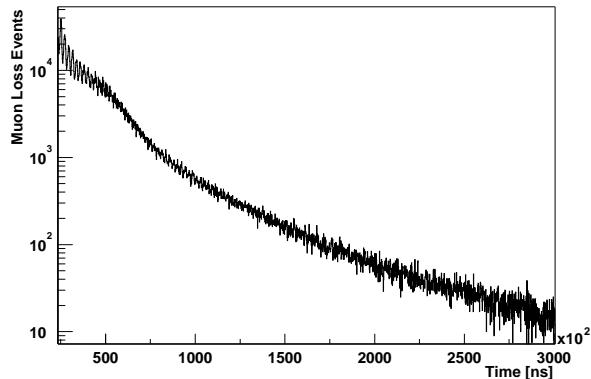

FIG. 35: Muon loss rate vs. time from the R00 period. Three consecutive and coincident FSD station signals form the muon loss signal. The loss function $L(t)$ is proportional to this raw data plot.

Equation 34 defines $V(t)$, which accounts for an acceptance modulation owing to vertical betatron oscillations of the stored muon beam—the vertical waist—having angular frequency $\omega_{VW} \approx (1 - 2\sqrt{n})\omega_c$. The vertical waist dephases with a characteristic de-coherence time $\tau_{VW} \approx 25 \mu\text{s}$. The frequency and de-coherence time are determined in dedicated early-start-time fits on isolated detectors—when the vertical waist is large—and they are found to be consistent with expectations from beam dynamics calculations. The phase is the only free parameter in the physics fits. The term $V(t)$ is important in fits that start before $30 \mu\text{s}$.

During scraping, which is completed $7 - 15 \mu\text{s}$ after injection, the muon beam is displaced both vertically and horizontally. As the quadrupole voltages return to their nominal storage values, the beam returns to the aperture’s center. The relaxation time of $5 \pm 1 \mu\text{s}$ is observed directly in the mean position of decay positrons on the FSD (see Fig. 23). The term $B(t)$ modifies the normalization constant N_0 and accounts for the corresponding change in acceptance. As was the case for $V(t)$, $B(t)$ is important only for fits which start at very early times.

The horizontal CBO describes the modulation of the normalization, phase and asymmetry: N , A and ϕ . The modulation of N and A results from the changing acceptance for detecting decay positrons as the beam oscillates radially. The modulation in ϕ results from changes in the drift time. The amplitudes and phases in Eqs. 36 - 38 are difficult to predict and are therefore determined from the fit. Nonetheless, fit results for these parameters are

consistent with Monte Carlo predictions, including variations by detector. The damping of the CBO is adequately described by an exponential having the common decay time constant τ_{cbo} in the range 90 – 130 μ s (dependent on quadrupole voltage). The horizontal CBO frequency and lifetime are independently determined using the FSD detectors. As the muons move in and out in the horizontal plane of the storage ring, the average path length for the decay positrons to strike the detectors grows shorter and longer. As a result, the rms *vertical* width on the face of the detectors oscillates at the horizontal CBO frequency with an amplitude that decays with characteristic time τ_{cbo} . The CBO frequency and lifetime, measured using the FSD detectors, are consistent with those obtained from the multi-parameter fits to the calorimeter data.

No CBO terms were used in the R98 fitting function. The small CBO modulation was largely hidden, given the low statistical power of the data set and the fact that the final histograms were formed from sums of the individual detector time spectra. The effect of the CBO would cancel exactly in the sum if the acceptance around the ring were uniform. However, kicker and, to a lesser degree, quadrupole electrodes—upstream of particular detector stations—lower the acceptance of those detectors, breaking the symmetry. Still, the CBO effect is reduced by an order of magnitude in the sum. However, fits to the much larger R99 data set gave a poor χ^2/dof before accounting for CBO modulation of the normalization, which was incorporated by multiplying N_{ideal} by the function

$$C'(t) = 1 + A_{cbo}e^{-t^2/\tau_{cbo}^2} \cos(\omega_{cbo}t + \phi_{cbo}). \quad (39)$$

With this modification, the χ^2/dof was acceptable (alternatively, Eq. 36 was also used and, in subsequent analyses, became the standard method to account for CBO). The fit value $A_{cbo} \simeq 0.01$ was in good agreement with that found from the full detector simulation. The conservative systematic error of ± 0.05 ppm was assigned, based on changes to the ω_a frequency when varying the CBO fit parameters over wide ranges.

After the R00 running was concluded, it was discovered that the CBO frequency was unusually close to twice the $(g - 2)$ frequency; that is, $\omega_{cbo} - \omega_a \approx \omega_a$. Analytic and simulation studies indicate that in this case, the fit value of ω_a is particularly sensitive to the CBO modulation. Figure 36 shows the relative pull ($\Delta\omega$) versus the CBO modulation frequency *if not* addressed by the fitting function. As evident in the figure, the R00 data were acquired under run conditions in which ω_a was very sensitive to CBO. Accordingly,

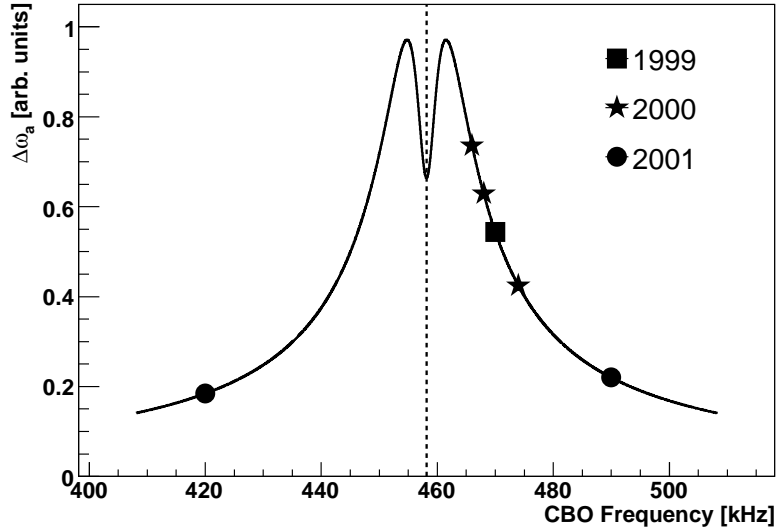

FIG. 36: The relative pull ($\Delta\omega$) versus the CBO modulation frequency *if not* addressed by the fitting function. A typical full vertical scale is several ppm; the actual scale depends on the specifics of the fit and the data set used. The R00 data were acquired under run conditions in which ω_a was very sensitive to CBO. This sensitivity was minimized in the R01 period where low- and high- n subperiods, each having CBO frequencies well below or above twice the $(g - 2)$ frequency, were employed.

the systematic uncertainty for this period is larger than the R01 period, which featured low- and high- n subperiods, each having CBO frequencies well below or above twice the $(g - 2)$ frequency. The CBO systematic uncertainties were conservatively estimated to be ± 0.21 ppm and ± 0.07 ppm for the R00 and R01 periods, based on varying the fixed CBO fit parameters over large ranges and comparing the ω_a fit values from fits to the single detector data and all detector data.

Table XII shows a representative correlation matrix from a fit to the low- n data set in the R01 period. The $V(t)$ and $B(t)$ terms are omitted because they are negligible for the fit start time of $31.8 \mu\text{s}$ in this fit. Note that none of the terms—apart from the $(g - 2)$ phase—correlates strongly with ω_a .

TABLE XII: Correlation matrix $\text{cov}(p_i p_j)/\sigma_i \sigma_j$ from a fit to the low- n data from R01 starting at $31.8 \mu\text{s}$.

The $V(t)$ and $B(t)$ terms have been omitted because they are negligible for this fit start time.

	N_0	A	τ	ϕ	ω_a	ω_{cbo}	τ_{cbo}	A_1	ϕ_1	A_2	ϕ_2	A_3	ϕ_3	A_{loss}
N_0	1.000	-0.040	0.816	-0.010	0.007	0.017	-0.022	0.030	-0.025	-0.023	0.028	-0.013	-0.071	0.982
A	-0.040	1.000	-0.025	-0.008	0.004	0.006	0.011	-0.014	-0.010	0.066	0.038	-0.068	0.016	-0.037
τ	0.816	-0.025	1.000	-0.007	0.005	0.010	-0.013	0.018	-0.015	-0.014	0.018	-0.010	-0.044	0.873
ϕ	-0.010	-0.008	-0.007	1.000	-0.834	0.018	-0.025	0.035	-0.024	0.054	-0.082	0.004	0.068	-0.009
ω_a	0.007	0.004	0.005	-0.834	1.000	-0.013	0.018	-0.026	0.017	-0.040	0.058	-0.002	-0.050	0.007
ω_{cbo}	0.017	0.006	0.010	0.018	-0.013	1.000	-0.004	0.007	-0.319	0.002	-0.049	-0.002	-0.016	0.015
τ_{cbo}	-0.022	0.011	-0.013	-0.025	0.018	-0.004	1.000	-0.903	0.003	0.132	0.005	0.016	-0.007	-0.020
A_1	0.030	-0.014	0.018	0.035	-0.026	0.007	-0.903	1.000	-0.006	-0.134	-0.007	-0.010	0.008	0.028
ϕ_1	-0.025	-0.010	-0.015	-0.024	0.017	-0.319	0.003	-0.006	1.000	-0.003	0.046	-0.001	0.014	-0.023
A_2	-0.023	0.066	-0.014	0.054	-0.040	0.002	0.132	-0.134	-0.003	1.000	-0.006	0.009	0.023	-0.021
ϕ_2	0.028	0.038	0.018	-0.082	0.058	-0.049	0.005	-0.007	0.046	-0.006	1.000	-0.007	0.005	0.026
A_3	-0.013	-0.068	-0.010	0.004	-0.002	-0.002	0.016	-0.010	-0.001	0.009	-0.007	1.000	-0.015	-0.013
ϕ_3	-0.071	0.016	-0.044	0.068	-0.050	-0.016	-0.007	0.008	0.014	0.023	0.005	-0.015	1.000	-0.065
A_{loss}	0.982	-0.037	0.873	-0.009	0.007	0.015	-0.020	0.028	-0.023	-0.021	0.026	-0.013	-0.065	1.000

6. The ratio-fitting method

An alternative analysis of ω_a first randomly sorts the electron time spectra into four equal subsets, labelled $n_1(t)$ through $n_4(t)$. Each is similar to the standard $N(t)$ distribution. The four subsets are then recombined in the ratio

$$r(t) = \frac{n_1\left(t + \frac{1}{2}T\right) + n_2\left(t - \frac{1}{2}T\right) - n_3(t) - n_4(t)}{n_1\left(t + \frac{1}{2}T\right) + n_2\left(t - \frac{1}{2}T\right) + n_3(t) + n_4(t)} \quad (40)$$

to produce a spectrum as shown in Fig. 37. Here, $T = 2\pi/\omega_a$ is a (very good) estimate of the spin precession period. In preparing the ratio histograms, gain corrections are applied to the data and pileup and fast rotation are removed. The ratio histograms can then be fit well by a three-parameter function, which accounts for the amplitude, frequency and phase of the spin precession:

$$r_3(t) = A \cos(\omega_a t + \phi) + \frac{1}{16} \left(\frac{T}{\gamma\tau_\mu} \right)^2. \quad (41)$$

The final term arises from the exponential decay when shifting the subsets forward or backward in time by $T/2$. Equation 41 describes well the ratio histograms formed when data from all detectors are combined. In the R01 analysis, it was used successfully to fit the detector-combined data from both n -value data sets.

However, Eq. 41 is inadequate in fitting individual detector data subsets, or those of a given field index, as was done in an independent analysis of the R01 data. The ratio function must be expanded to incorporate the CBO modulation of the normalization, asymmetry and phase, as described for the multi-parameter fitting. Therefore, Eq. 41 is replaced by the more general nine-parameter function

$$r_9(t) = \frac{2f_0(t) - f_+(t) - f_-(t)}{2f_0(t) + f_+(t) + f_-(t)} \quad (42)$$

where

$$f_0(t) = C(t) \cdot (1 + A(t) \cos(\omega_a t + \phi(t))) \quad (43)$$

and

$$f_{\pm}(t) = C(t') e^{\mp T/(2\gamma\tau_\mu)} \cdot [1 + A(t') \cos(\omega_a t + \phi(t'))] \quad (44)$$

with $C(t)$, $A(t)$ and $\phi(t)$ defined in Eqs. 36, 37, and 38, and with $t' = t \pm T/2$. This expression is sufficient to obtain good fits to individual data subsets.

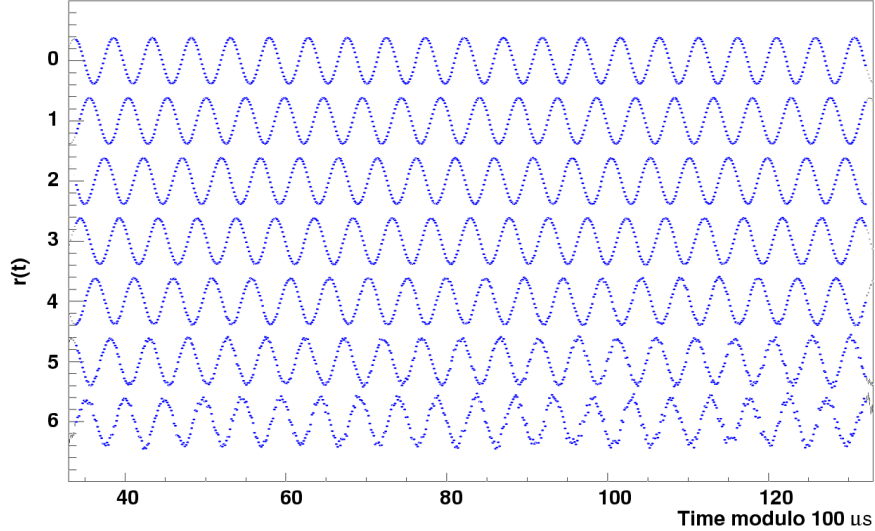

FIG. 37: Ratio spectrum from the R01 period. The top band begins $27 \mu\text{s}$ after injection. For display purpose, each successive $100 \mu\text{s}$ band is displaced downward.

7. The asymmetry-weighting method

In the standard multi-parameter or ratio fitting described above, the statistical error on the frequency ω_a is

$$\frac{1}{\sigma_{\omega_a}^2} = \frac{\mathcal{N}\langle A \rangle^2(\gamma\tau_\mu)^2}{2}, \quad (45)$$

where $\langle A \rangle$ is the average of the asymmetry of the \mathcal{N} events having energy greater than E_{th} . In the asymmetry-weighting method, each decay is weighted by the asymmetry, the weight being implied by the nominal $A(E)$ relationship. The resulting statistical error

$$\frac{1}{\sigma_{\omega_a}^2} = \frac{\mathcal{N}\langle A^2 \rangle(\gamma\tau_\mu)^2}{2} \quad (46)$$

is optimized. The difference between Eqs. 45 and 46 is the asymmetry term, $\langle A^2 \rangle$ vs. $\langle A \rangle^2$, which reduces the uncertainty by 10 percent. The systematic sensitivities are different but of comparable size. This method is equivalent to binning and analyzing the data in discrete energy bins in the limit of an infinite number of bins.

8. Internal and mutual consistency

Before the individual offsets assigned to the analyses can be replaced by a single common offset, each analysis must demonstrate a high level of internal consistency. Then, before

the common offset is removed, the results of the different analyses are examined for mutual consistency.

Internal consistency demands:

- a reduced χ^2 equal to unity within the expected statistical spread;
- no pronounced structures in the fit residuals, both in the time and frequency domains;
- that the fit results must be independent of any specific subset of data, within expected statistical and systematic errors.

The optimal set of parameters is obtained by minimizing χ^2 , defined as

$$\chi^2 = \sum_{\text{bins}} \frac{[N_i - F(t_i, \vec{\alpha})]^2}{\sigma_i^2}. \quad (47)$$

The error σ_i must account for pileup subtraction. In some analyses it was calculated during the pileup correction procedure, as a combination of the contents of the bin and the amount subtracted from that bin. In others, it was approximated as $(1 + k e^{-t/\gamma\tau}) F(t_i, \vec{\alpha})$. The latter method was inspired by the observation that without pileup subtraction, $\sigma_i^2 = F(t_i, \vec{\alpha})$, that is the best estimate of the error squared at any point is given by the fit value itself. The factor $(1 + k e^{-t/\gamma\tau})$ reflects a small correction because of the pileup subtraction.

The quality of the fits is tested by splitting the data into subsets, especially those that enhance or reduce particular systematic uncertainties. In estimating the impact of statistical fluctuations in the comparison of subset fits, the data overlap and change in analyzing power (notably the asymmetry) has to be taken into account.

Data subset comparisons include:

- **Start time:** As the fit start times increase, the effects of short time-constant ($< \gamma\tau$) perturbations— $V(t), B(t)$, fast rotation, pileup, gain changes—disappear. Therefore the stability of results versus start time is one of the most sensitive measures of a good fitting function.
- **Run conditions:** Fits are carried out on individual runs or sets of runs having special experimental conditions. Examples include variations in n values, quadrupole scraping voltage or timing, and radial magnetic field. Data from each of the 12 bunches in an AGS cycle were considered separately and compared.

- **Electron energy:** Data are sorted into discrete energy bins (typically 200 MeV wide) or into sets having different low-energy thresholds. Fits to these data sets are naturally quite sensitive to the details of energy scale and pileup corrections.
- **Detector:** Fits are carried out on data from individual detectors, on detector groups, and on the sum of all detectors. This division is particularly sensitive to a correct treatment of CBO and of the early-time background, which are highly dependent on position around the ring.

Figure 38 is a representative set of important fit subset tests for one of the R00 multi-parameter analyses. Individual fits all had acceptable reduced χ^2 . The top left panel shows the stability of the precession frequency versus start time of the fit. The sideways “parabolic” band defines the expected range of successive results, given the initial fit value and the steady diminution of the data set. The outer envelope represents the statistical uncertainty on any individual fit. The top right panel shows the ω_a results for data binned in 200 MeV energy bands, for a fixed start time. This distribution is flat, as expected. The bottom left panel shows the result as a function of detector station around the ring [40]. Data were divided into subsets indexed by both detector number and energy band. The consistency of the ω_a values can be verified by calculating the mean of the ensemble and plotting the deviation of each individual fit, normalized by the respective statistical error. The result, shown in the bottom right panel, is a Gaussian of width 1, as expected.

The expected spread in fitting results for data sets that partially overlap depends on the size of the data samples, as well as on the difference in analyzing power—the asymmetry and the phase of the $(g - 2)$ modulation—giving

$$\sigma_{diff} = \sqrt{\sigma_2^2 - \sigma_1^2 \left(2 \frac{A_1}{A_2} \cos(\phi_1 - \phi_2) - 1 \right)}. \quad (48)$$

Here, the larger data set is indicated by subscript 1 and the smaller, fully-contained subset, by subscript 2. Data sets having different energy thresholds will have a different analyzing power. In the case that the analyzing powers are the same ($A_1 \simeq A_2$ and $\phi_1 \simeq \phi_2$), Eq. 48 reduces to

$$\sigma_{diff} \simeq \sqrt{\sigma_2^2 - \sigma_1^2}, \quad (49)$$

a result that is applicable to nearly all of the consistency tests, and is the basis of the envelope shown in Fig. 38.

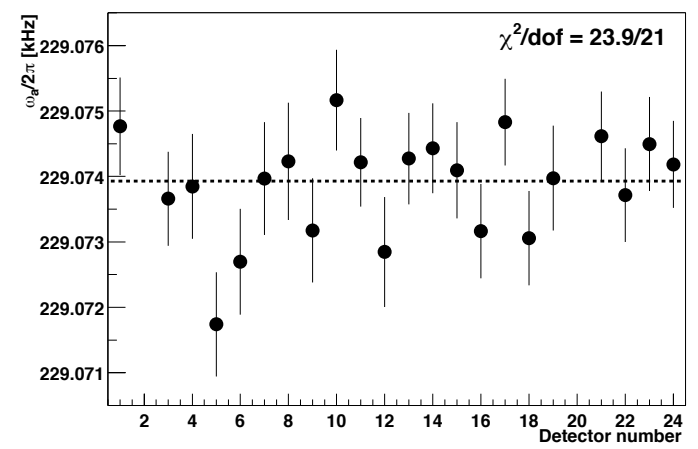
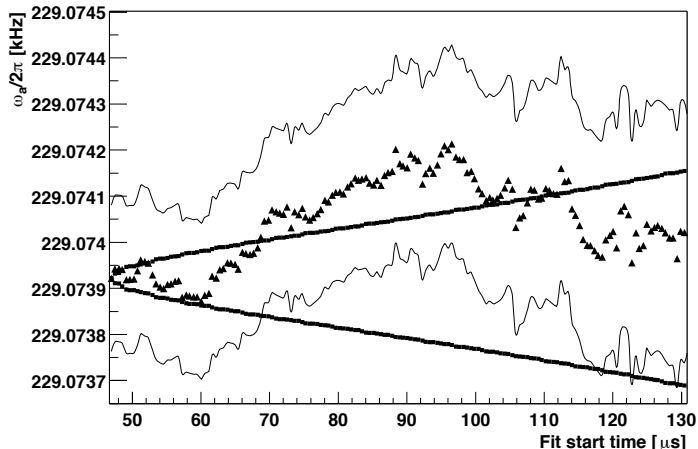
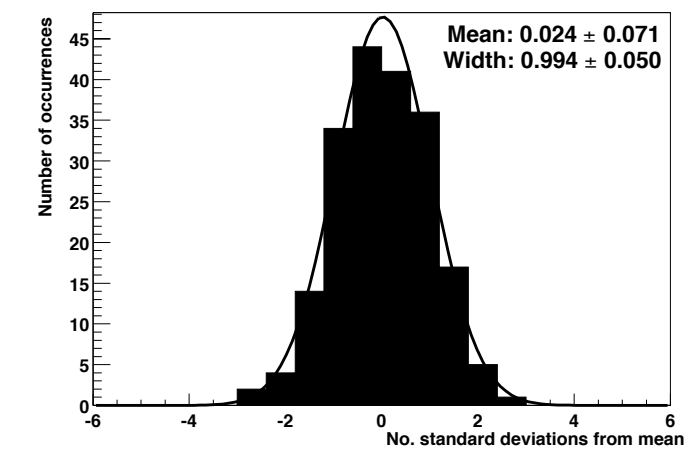
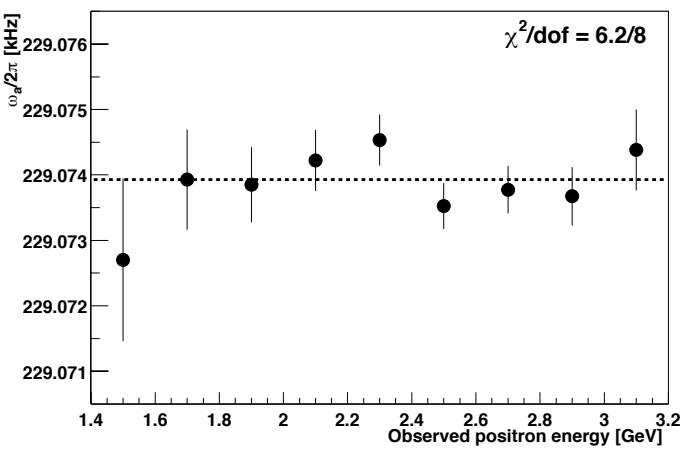

FIG. 38: From a multi-parameter fitting of the R00 period data. Precession frequency: a) versus start time of the fit; b) versus detector; c) versus energy bin; d) The difference between the precession frequency from each of the 198 individual fits of energy and detector subsets of the data compared to the mean. Unit width is expected for a statistical distribution. In a), the sideways “parabolic” band defines the expected range of successive results while the outer envelope represents the statistical uncertainty on any individual fit.

TABLE XIII: Comparison of the fitted relative precession frequency R from each of the analyses. The units are ppm. The uncertainties are statistical and systematic, respectively. Note that the variation in the magnetic field from year to year has *not* been corrected for. The labels A - E represent individual, independent analysis efforts for any given running period.

Analysis	R99	R00	R01
A	$119.60 \pm 1.23 \pm 0.08$	$113.97 \pm 0.70 \pm 0.26$	$108.63 \pm 0.63 \pm 0.24$
B	$119.33 \pm 1.28 \pm 0.19$	$113.74 \pm 0.63 \pm 0.34$	$107.98 \pm 0.69 \pm 0.28$
C	$119.38 \pm 1.24 \pm 0.22$	$113.57 \pm 0.64 \pm 0.36$	$108.36 \pm 0.69 \pm 0.22$
D	$119.67 \pm 1.28 \pm 0.17$	$113.83 \pm 0.64 \pm 0.35$	$108.31 \pm 0.71 \pm 0.23$
E	$119.55 \pm 1.24 \pm 0.22$		$107.96 \pm 0.72 \pm 0.19$

Results from the individual analyses were required to be statistically compatible. When comparing different analyses of the same nominal data set, a correct assessment of the expected deviations must include a careful analysis of the data overlap. Each analysis included the same accepted runs but the data overlap differed at the few percent level, as explained in Sec. IV B 1, because of the individual techniques employed. For example, some of the more aggressive analyses used very early start times or included a broader energy range of accepted electrons.

Table XIII gives the final, offset-removed, relative precession frequency results for the R99, R00 and R01 running periods based on the 14 analyses. The parameter ω_a is encoded in all the fitting programs as

$$\omega_a = 2\pi \cdot 0.2291 \text{ MHz} \cdot [1 - (R - \Delta R) \times 10^{-6}] \quad (50)$$

where R is the actual free parameter and ΔR is the secret offset for the given running period. In this convenient form, the precession results listed in Table XIII are in ppm. The R values cannot be compared *across* running periods without further computation because the mean magnetic field changed from year to year.

The individual a_μ results for the R99, R00, and R01 running periods are shown in Fig. 39. The results within a period are highly correlated. The analysis methods are coarsely distinguished by raw-event production, `g20ff` (`g2`) or `G2Too` (`G2`), and by the multi-parameter (`MP`) or ratio-method (`R`) of fitting. The `G2-MP` result from the R01 period used the asymmetry-weighting method and the `G2-MP` result from the R00 period was based on an energy-binned

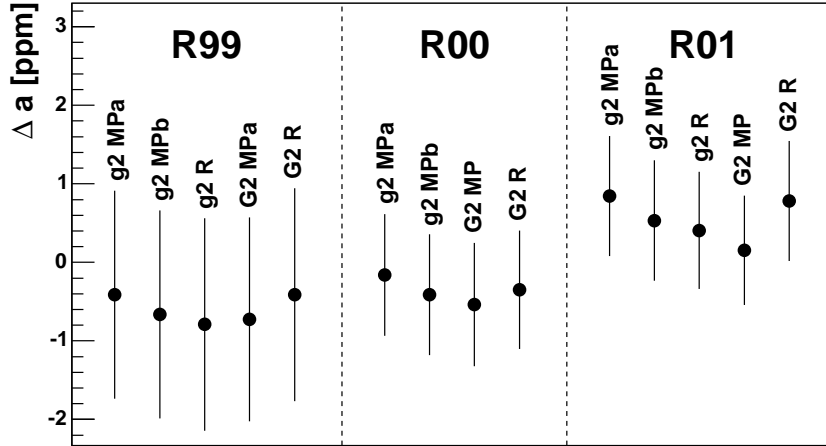

FIG. 39: Results for the anomalous magnetic moment from the 14 different ω_a analyses performed in the R99, R00 and R01 running periods. The analysis methods are coarsely distinguished by raw-event production, `g20ff` (`g2`) or `G2Too` (`G2`), and by the multi-parameter (MP) or ratio-method (R) of fitting. The results in a given period are highly correlated: the event samples largely overlap.

method (an indirect asymmetry weighting).

9. Systematic errors in ω_a

The systematic uncertainties have been described in the relevant sections. Table XIV lists the numerical values, with appropriate combinations of uncertainties taken into account for the different analyses for each period.

For each running period, the final quoted result is obtained from a statistical average of the individual results from each analysis. This method of combination is robust, given that each analysis is individually believed to be correct. Each analysis included a complete and independent evaluation of all fit-related systematic uncertainties. The methods, being different, feature somewhat different sensitivities to individual uncertainties. For example, `g2Too` and `G20ff`-based productions have pulse-finding algorithm differences and pileup sensitivities. Multi-parameter versus ratio fitting implies different sensitivity to slow terms such as muon loss. The CBO sensitivity depends on whether the analysis sums over all detec-

TABLE XIV: Systematic errors for ω_a in the R99, R00 and R01 data periods. ‡ In R01, the AGS background, timing shifts, E field and vertical oscillations, beam debunching/randomization, binning and fitting procedure together equaled 0.11 ppm.

$\sigma_{\text{syst}} \omega_a$	R99	R00	R01
	(ppm)	(ppm)	(ppm)
Pileup	0.13	0.13	0.08
AGS background	0.10	0.01	‡
Lost Muons	0.10	0.10	0.09
Timing Shifts	0.10	0.02	‡
E-field and pitch	0.08	0.03	‡
Fitting/Binning	0.07	0.06	‡
CBO	0.05	0.21	0.07
Gain Changes	0.02	0.13	0.12
Total for ω_a	0.3	0.31	0.21

tors or treats them individually. Gain changes depend on the pileup subtraction treatment and the start time selected. The published values take into account these differences in the assignment of a systematic uncertainty for the final result.

10. Consideration of a muon EDM

Before presenting the final result, we remark on the possible effect on the precession frequency from a non-zero muon electric dipole moment (EDM). Equation 11, which gives the dependence of a_μ on the measured difference frequency (ω_a), tacitly assumes that the muon EDM is zero ($d_\mu = 0$). A non-zero EDM requires a modification of Eq. 5:

$$\vec{\omega} = \vec{\omega}_a + \vec{\omega}_{EDM} = \vec{\omega}_a - \frac{q\eta}{2m} (\vec{\beta} \times \vec{B}), \quad (51)$$

where η is a unitless constant proportional to the EDM:

$$\vec{d}_\mu = \frac{\eta q}{2mc} \vec{S}. \quad (52)$$

The interaction of the EDM with the motional electric field (in the muon rest frame) induces a radial component in the spin precession vector, which is otherwise purely vertical. The spin precession plane is tilted radially by angle δ :

$$\delta \approx \frac{\eta}{2a_\mu} = \frac{d_\mu}{1.1 \times 10^{-16} \text{ e cm}}. \quad (53)$$

Independent of its sign, an EDM increases the measured precession frequency,

$$\omega_{meas} = \omega_a \sqrt{1 + \delta^2}. \quad (54)$$

A precession plane tilt causes an oscillation at ω_{meas} in the vertical direction of the decay electrons and thus in the mean vertical position at the calorimeters. The vertical oscillation reaches extrema when the spin points inward or outward radially, 90° out of phase with the usual $(g - 2)$ oscillation.

The vertical electron hit distribution on the FSDs was examined for oscillations having this phase relation. Additionally, the traceback wire chambers were used to look for oscillations in the vertical decay angle of the electrons. Both methods find null results. The final analysis of the EDM studies from our experiment is being completed and we expect to achieve a limit of a few times 10^{-19} e cm. The details will be described in a separate paper [41]. However, to set the scale of the potential effect, a non-zero EDM at 2.0×10^{-19} e cm would cause a systematic increase to a_μ by 1.6 ppm. A more sensitive limit is obtained by invoking muon-electron universality and the linear scaling relation expected for many standard model extensions: $d_\mu \approx (m_\mu/m_e)d_e$. With the current electron EDM limit, $d_e < 1.6 \times 10^{-27}$ e cm, linear scaling implies a muon upper limit below 3.2×10^{-25} e cm. An EDM of this magnitude is too small to affect the ω_a measured in this experiment. Therefore, we adopt the assumption that the measured anomalous precession frequency alone determines a_μ .

C. Final a_μ result

The final a_μ result is obtained by combining the individual a_μ results from all running periods, which are listed in Table I. All E821 results are plotted in Figure 40 together with the final average.

Recall that the relation

$$a_\mu = \frac{\mathcal{R}}{\lambda - \mathcal{R}}$$

is used to determine a_μ , where the ratio $\mathcal{R} = \omega_a/\tilde{\omega}_p$ is the experimental measurement: the anomalous precession frequency divided by the event-weighted magnetic field. The muon-to-proton magnetic moment ratio $\lambda = \mu_\mu/\mu_p = 3.183\,345\,39(10)$ is obtained independently [12]. The appropriate comparison of results from E821 is made in terms of \mathcal{R} . The precession frequencies, radial electric field and pitch corrections, average magnetic field and \mathcal{R} ratios are given in Table XV for the R99, R00 and R01 periods. Total uncertainties are given for each quantity. While the magnetic field strength differed slightly from year to year, and consequently the precession frequency changed, the agreement in \mathcal{R} between periods is excellent.

Correlations in certain systematic uncertainties exist across running periods. These include the use of a common absolute calibration probe, perturbations to the storage ring field from kicker eddy currents, uncertainty in the lost muon population phase, and the E /pitch correction. Their combined uncertainty is less than 0.15 ppm. Other systematic uncertainties are uncorrelated, as are the statistical uncertainties. The errors quoted on combined results reflect a slight increase compared to a direct weighted error because of correlations across periods.

The two positive muon values for \mathcal{R} can be combined and compared to the negative muon result:

$$\mathcal{R}_{\mu^+} = 0.003\,707\,204\,7(2\,6) \quad (55)$$

$$\mathcal{R}_{\mu^-} = 0.003\,707\,208\,3(2\,6), \quad (56)$$

giving $\Delta\mathcal{R} = \mathcal{R}_{\mu^-} - \mathcal{R}_{\mu^+} = (3.6 \pm 3.7) \times 10^{-9}$, which is in good agreement with the expectation from CPT invariance. Assuming CPT invariance, we obtain the average value

$$\mathcal{R}_\mu(\text{E821}) = 0.003\,707\,206\,4(2\,0), \quad (57)$$

giving the anomalous magnetic moment

$$a_\mu(\text{Expt}) = 11\,659\,208.0(6.3) \times 10^{-10} \quad (0.54 \text{ ppm}). \quad (58)$$

The total uncertainty includes a 0.46 ppm statistical uncertainty and a 0.28 ppm systematic uncertainty, combined in quadrature.

TABLE XV: Individual ω_a and $\tilde{\omega}_p$ results, and the ratio for the three high-statistics running periods. Column 3 gives the relative electric field and pitch corrections, which have been applied to the ω_a values quoted in column 2. The total uncertainties for each quantity are given. The error on the average takes into account correlations between the inter-period systematic uncertainties.

Period	$\omega_a/(2\pi)$ [Hz]	E/pitch [ppm]	$\tilde{\omega}_p/(2\pi)$ [Hz]	$\mathcal{R} = \omega_a/\tilde{\omega}_p$
R99 (μ^+)	229 072.8(3)	+0.81(8)	61 791 256(25)	0.003 707 204 1(5 1)
R00 (μ^+)	229 074.11(16)	+0.76(3)	61 791 595(15)	0.003 707 205 0(2 5)
R01 (μ^-)	229 073.59(16)	+0.77(6)	61 791 400(11)	0.003 707 208 3(2 6)
Average	–	–	–	0.003 707 206 3(2 0)

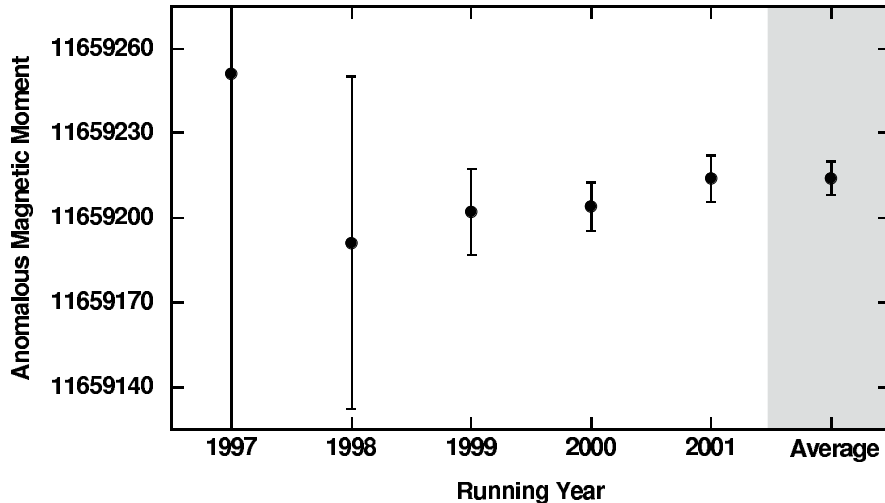

FIG. 40: Results for the E821 individual measurements of a_μ by running year, together with the final average.

V. THE STANDARD MODEL VALUE OF THE ANOMALY

Three classes of radiative processes contribute to a_μ : QED loops containing photons and leptons (e, μ, τ); hadronic loops (Had) containing hadrons in vacuum polarization loops; and weak (Weak) loops involving the W, Z , and Higgs bosons. The standard model anomaly is represented by the expression

$$a_\mu(\text{SM}) = a_\mu(\text{QED}) + a_\mu(\text{Had}) + a_\mu(\text{Weak}). \quad (59)$$

While the QED and electroweak contributions are well understood, the hadronic terms remain the subject of intensive study. Recent reviews of the complete standard model calculation are given by Davier and Marciانو [42] and by Passera [43]. Their accounting of the individual contributions is summarized below; however, we include only those results that have been published in refereed journals.

The QED contributions to a_μ are calculated through four loops and an estimate is made of the leading five-loop term [44]. The total QED value is

$$a_\mu(\text{QED}) = 11\,658\,471.958(0.002)(0.115)(0.085) \times 10^{-10} \quad (60)$$

where the first two uncertainties are from the α^4 and α^5 terms, respectively, and the third is from the uncertainty on α . The value and uncertainty on α are obtained from atom interferometry [44].

The electroweak contribution from one and two loops is

$$a_\mu(\text{Weak}) = 15.4(0.1)(0.2) \times 10^{-10} \quad (61)$$

where the first error comes from two-loop electroweak hadronic effects in the quark triangle diagrams and the second comes from the uncertainty on the Higgs mass [42, 45].

Establishing an accurate and precise value for the hadronic contributions to a_μ is the source of much theoretical and experimental work worldwide. The lowest-order hadronic vacuum polarization loop (Had; LO), shown in Fig. 41(a), contributes approximately 60 ppm to a_μ . This diagram can be evaluated using the dispersion relation shown pictorially in Fig. 41(a-b), which connects the bare cross section for electroproduction of hadrons to the hadronic vacuum polarization contribution to a_μ :

$$a_\mu(\text{Had; LO}) = \left(\frac{\alpha m_\mu}{3\pi}\right)^2 \int_{4m_\pi^2}^{\infty} \frac{ds}{s^2} K(s) R(s), \quad (62)$$

where

$$R(s) \equiv \frac{\sigma_{\text{tot}}(e^+e^- \rightarrow \text{hadrons})}{\sigma_{\text{tot}}(e^+e^- \rightarrow \mu^+\mu^-)}, \quad (63)$$

and $K(s)$ is a kinematic factor. The measured cross section ratio $R(s)$ is the critical input to the evaluation. The s^{-2} dependence of the kernel weights preferentially the values of $R(s)$ at low energies (e.g., near the ρ resonance) and, consequently, the low-energy region dominates the determination of $a_\mu(\text{Had; LO})$. The higher-energy region is less critical [46].

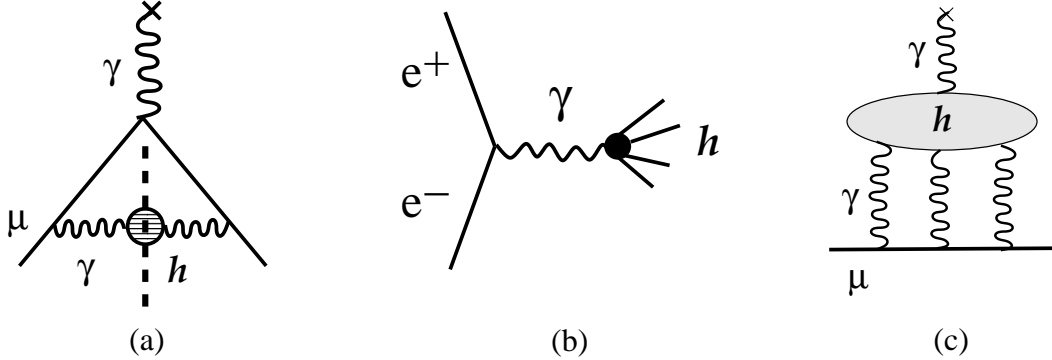

FIG. 41: (a) The lowest order “cut” hadronic vacuum polarization diagram and (b) the electroproduction of hadrons, which is related to (a) through a dispersion relation. (c) The hadronic light-by-light contribution.

The most precise data entering the dispersion relation at low energies are from the CMD2 experiment at Novosibirsk [47]. The CMD2 experiment measures $R(s)$ by sweeping the center-of-mass collision energy of the positron and electron beams in the VEPP-II ring. An alternate way of obtaining $R(s)$ is exploited by the KLOE collaboration at Frascati [48]. They operate at a fixed e^+e^- collision energy corresponding to resonant ϕ production. The hadronic cross sections at lower energies are obtained from events having an initial-state radiated photon, which reduces the actual center-of-mass collision energy.

The contribution to the dispersion integral from threshold to the τ mass can also be derived from hadronic τ decays by invoking the conserved vector current hypothesis and by making necessary isospin corrections. For example, the decay rate for $\tau^- \rightarrow \pi^- \pi^0 \nu_\tau$ can be related to the e^+e^- annihilation cross section into $\pi^+\pi^-$ [46, 49, 50, 51]. Because the τ data only contain an isovector component, the isoscalar piece present in e^+e^- annihilation has to be put in “by hand” to evaluate $a_\mu(\text{Had}; \text{LO})$. The τ -data approach is attractive because a large body of high-precision data exists from the LEP experiments and from CLEO. Unfortunately, there are significant inconsistencies between these data and those obtained in direct e^+e^- annihilation [46]. For example, the τ branching ratios predicted from the e^+e^- data do not agree, nor do the shapes of F_π obtained from either the e^+e^- or τ data. Because of this inconsistency, we compared only to the direct e^+e^- annihilation data using the two recently published analyses [46, 52] for the $a_\mu(\text{Had}; \text{LO})$ contribution (see Table XVI). Use of the τ data leads to a higher dispersion integral.

Higher-order hadronic contributions fall into two classes. The first class represents modifications of Fig. 41(a) with an additional vacuum polarization loop (hadronic or leptonic), or with a photon loop along with the hadronic vacuum polarization loop. These contributions, (Had; HO), can be calculated from a dispersion relation with a different kernel function and experimental data. Using the kernel function of Krause [53], the evaluations reported in Refs. [46, 52] find $(-10.0 \pm 0.6) \times 10^{-10}$ and $(-9.8 \pm 0.1) \times 10^{-10}$, respectively, which are in good agreement and of sufficient precision compared to the experimental uncertainty on a_μ .

The hadronic light-by-light (Had; LbL) contribution shown in Fig. 41(c) must be calculated using a theoretical model. Its evaluation has been the focus of considerable theoretical activity [54, 55, 56, 57, 58, 59]. In recent work, Melnikov and Vainshtein (MV) report $13.6(2.5) \times 10^{-10}$ (0.22 ppm) [59], roughly 50 percent larger than that obtained in earlier efforts by others [54, 55, 56, 57]. This value is found by ignoring several small negative contributions. For this reason, in their review [42], Davier and Marciano assign $12(3.5) \times 10^{-10}$ for this contribution, the central value being an alternate result reported by MV [59]. The conservative uncertainty in the DM review expands the range to include the earlier results. We use the DM recommendation in our summary.

The standard model theoretical summary is given in Table XVI. Two results are presented, representing the two slightly different e^+e^- -based evaluations of the leading-order hadronic vacuum polarization contribution. The theoretical expectation should be compared to our experimental result (Eq. 58):

$$a_\mu(\text{Expt}) = 11\,659\,208.0(6.3) \times 10^{-10} \quad (0.54 \text{ ppm}).$$

The difference

$$\Delta a_\mu(\text{Expt} - \text{SM}) = (22.4 \pm 10 \text{ to } 26.1 \pm 9.4) \times 10^{-10}, \quad (64)$$

has a significance of 2.2 to 2.7 standard deviations. Use of the τ -data gives a smaller discrepancy.

To show the sensitivity of the measured muon $(g - 2)$ value to the electroweak gauge bosons, the electroweak contribution given in Eq. 61 is subtracted from the standard model values in Table XVI. The resulting difference with theory is

$$\Delta a_\mu = (38 \text{ to } 41 \pm 10) \times 10^{-10}, \quad (65)$$

TABLE XVI: Contributions to the standard model value for a_μ . The error in ppm refers to the full value of a_μ . The errors listed for (Had; LO) are the quadrature of those from the data and from radiative corrections. The higher-order hadronic contribution does not include the hadronic light-by-light term, which is listed separately. In computing the total, the higher-order hadronic is taken from the same reference as the lowest-order hadronic.

Contribution	Value [10^{-10}]	Error	Error [ppm]	Reference
QED	11 658 471.958	0.143	0.012	[44]
Had; LO	696.3	7.2	0.62	[46]
Had; LO	692.4	6.4	0.55	[52]
Had; HO	-10.0	0.6	0.05	[46]
Had; HO	-9.8	0.1	0.01	[52]
Had; LBL	12	3.5	0.3	[42]
Weak	15.4	0.22	0.02	[42]
Total	11 659 185.7	8.0	0.69	[46]
	11 659 182.0	7.3	0.62	[52]

or a 3.7 to 4.3 standard deviation discrepancy when the electroweak contribution is left out.

The standard model value of the muon’s magnetic anomaly is entirely the result of radiative corrections from intermediate states formed from a wide range of known particles. It is also sensitive to speculative effects beyond the standard model such as additional gauge bosons, muon or gauge boson substructure or the existence of extra dimensions. Its value is potentially quite sensitive to the presence of as yet undiscovered particles associated with many generic manifestations of supersymmetry [42, 60].

VI. DISCUSSION AND CONCLUSIONS

Experiment E821 at Brookhaven is formally complete. All of the data are analyzed for a_μ and these independent muon anomalous magnetic moment evaluations have been reported [8, 9, 10]. Our combined result—based on nearly equal samples of positive and negative muons—represents a 14-fold improvement on the CERN-III experiment [5] of the

mid-1970's. Our final measurement uncertainty is 0.54 ppm, corresponding to 0.46 ppm statistical and 0.28 ppm systematic uncertainties, respectively. The magnetic field and muon spin precession systematics are combined. The experimental promise and progress since the proposal submission in 1984 motivated a significant theoretical effort to accurately predict the standard model expectation for the muon anomaly. The theoretical uncertainty, now 0.62 – 0.69 ppm, has been reduced by more than an order of magnitude over the same period. The difference between the measured and theoretical values, $(22 - 26) \times 10^{-10}$, lies within the expected range for many standard model extensions.

Our $(g - 2)$ Collaboration published individual results from the yearly running periods and these were compared to the most up-to-date theory expectations. Improvements in the theoretical calculations, new input data for the hadronic vacuum polarization analysis, and corrections to the theory changed the standard model central value appreciably over this time period. For example, the theoretical values quoted in Table XVI are higher by $\sim 24 \times 10^{-10}$ than the theory value quoted for our R99 result [8]. The dominant theoretical uncertainty is associated with the leading-order hadronic vacuum polarization. Further work is in progress at Novosibirsk, and additional data from both the CMD2 and SND experiments there will be published in the near future. The B factories at SLAC and KEK are also using initial-state radiation to measure $R(s)$, and results should be forthcoming. Continued theoretical modelling of the hadronic light-by-light contribution can also be expected, and initial studies using the lattice have begun [61]. We are confident that the precision on the standard model value will be improved, enabling a more sensitive comparison to experiment.

Because our measurement precision was ultimately limited by statistics, the question naturally arises whether the current technique can be extended using a more intense muon source. We have studied this question and have outlined a plan [62] that can reduce the present uncertainty on a_μ by a factor of 2.5 (or more), to a relative precision of ± 0.2 ppm. The effort requires straight-forward improvements in the magnetic field uniformity and mapping system and a five-fold increase in the muon production and storage rate. An important feature of the design is the use of a “backward” decay beam to eliminate the hadronic-induced flash. Other improvements are associated with increasing the muon transmission fraction, optimizing the kicker efficiency, and replacing the detectors with segmented calorimeters having independent readout digitizers.

Historically, precision tests of the standard model have led to both discoveries and refine-

ments in the predictive power of the theory. The series of CERN and BNL muon ($g - 2$) experiments—spanning more than 40 years—has methodically progressed such that the muon anomaly is now measured to sub-ppm precision. Over the same time, the standard model theoretical development has progressed, with QED loops evaluated through fourth order and estimated through fifth, weak loops through second order order, and hadronic loops through second order. Many standard model extensions—SUSY is just one example—suggest leading-order loops that will affect a_μ at the ~ 1 ppm (or slightly smaller) range. The present sensitivity of the muon anomaly test of the standard model is ± 0.9 ppm, with roughly equal contributions from theory and experiment. Theory uncertainty improvement can be expected from new experimental input for the hadronic contribution and from new calculational approaches for the hadronic light-by-light term. We have described an approach to improve the experiment uncertainty on the anomaly to ± 0.2 ppm. Thus, we may expect a significantly improved sensitivity for the anomaly test in the future. In the era of the LHC and direct searches for specific standard model extensions, precision measurements, such as that of the muon anomaly, represent a continually improving sum rule of known physics and provide independent insight into physics at high energies and short-distance scales.

VII. ACKNOWLEDGMENTS

Many people have made important contributions towards the success of E821 over the past twenty years when this experiment was proposed, built and completed. We thank N.P. Samios, R. Palmer, R.K. Adair, T.L. Trueman, M. Schwartz, T.B.W. Kirk, P.D. Bond, M. Murtagh[†], S. Aronson, D.I. Lowenstein, P. Pile and the staff of the BNL AGS for the strong support they have given; H. Hirabayashi and S. Kurokawa for their support of the magnet technology provided by KEK; J.M. Bailey, J.R. Blackburn, W. Earle, M.A. Green, E. Hazen, K. Ishida, J. Jackson, L. Jia, D. Loomba, W.P. Lysenko, J. Ouyang, W.B. Sampson, R.T. Sanders, and K. Woodle for their contributions to parts of the preparation and running of the experiment; J. Cullen[†], C. Pai, C. Pearson, I. Polk; L. Snydstrup, J. Benante, D. von Lintig and S. Kochis, who played major roles in the design and construction of the experiment. We gratefully acknowledge M. Tanaka[†] for his development of the AGS extraction system required for our experiment. We thank U. Haeberlen for his contributions to the development of the NMR magnetometer system. We thank our colleagues J. Bijnens, A. Czarnecki,

M. Davier, E. de Rafael, S.I. Eidelman, A. Höcker, F. Jegerlehner, T. Kinoshita and W. Marciano for very useful discussions on the theory.

We gratefully acknowledge L.M. Barkov for establishing the collaboration between the Budker Institute and E821, both at BNL and on the $R(s)$ measurements at BINP. W.W. Williams[†] (U. Michigan) made important contributions in the early phases of this work and in the development of the collaboration.

This work was supported in part by the U.S. Department of Energy, the U.S. National Science Foundation, the German Bundesminister für Bildung und Forschung, the Russian Ministry of Science, the US-Japan Agreement in High Energy Physics, the NATO Office of Scientific Research, and the U.S. National Computational Science Alliance. M. Deile, R. Prigl and A. Steinmetz acknowledge support by the Alexander von Humboldt Foundation. F.E. Gray was supported in part by a General Electric Fellowship, and C.S. Özben by the Scientific and Research Council of Turkey (TUBITAK). D.W. Hertzog acknowledges partial support from the John Simon Guggenheim Foundation during the writing of this manuscript.

-
- [1] J. Schwinger, Phys. Rev. **73**, 416 (1948).
 - [2] G. Charpak, F.J.M. Farley, R.L. Garwin, T. Muller, J.C. Sens, and A. Zichichi, Phys. Lett. **1**, 16 (1962).
 - [3] J. Bailey et al., Nuovo Cimento **A9**, 369 (1972).
 - [4] J. Aldins, S.J. Brodsky, A.J. Dufner and T. Kinoshita, Phys. Rev. D **1**, 2378 (1970).
 - [5] J. Bailey et al., Nucl. Phys. **B150**, 1 (1979).
 - [6] The $g - 2$ Collaboration: R.M. Carey et al., Phys. Rev. Lett. **82**, 1632 (1999).
 - [7] The $g - 2$ Collaboration: H.N. Brown et al., Phys. Rev. D **62**, 091101 (2000).
 - [8] The $g - 2$ Collaboration: H.N. Brown et al., Phys. Rev. Lett. **86**, 2227 (2001).
 - [9] The $g - 2$ Collaboration: G.W. Bennett et al., Phys. Rev. Lett. **89**, 101804 (2002); Erratum-
ibid. **89**, 129903 (2002).
 - [10] The $g - 2$ Collaboration: G.W. Bennett et al., Phys. Rev. Lett. **92**, 161802 (2004).
 - [11] E.J. Konopinski, Ann. Rev. Nucl. Sci. **9**, 99 (1959).
 - [12] W. Liu et al., Phys. Rev. Lett. **82**, 711 (1999).

- [13] The Particle Data Group: D.E. Groom et al., *The European Physical Journal* **C15**, 1 (2000).
- [14] S. O'Day, F. Bieniosek and K. Anderson, *New Target Results from the FNAL Antiproton Source* IEEE 1993 Part. Acc. Conf., vol. 4, 3096 (1993).
- [15] BTRAF, J. Sandweiss et al., BNL Bubble Chamber Group Report H-11 (1962), with additions by H. N. Brown (1982) and A. S. Carroll (1983).
- [16] A. Yamamoto et al., *Nucl. Instrum. Meth.* **A491**, 23 (2002).
- [17] Frank Krienen, Dinesh Loomba and Wuzheng Meng, *Nucl. Instrum. Meth.* **A283**, 5 (1989).
- [18] G.T. Danby et al., *Nucl. Instrum. Meth.* **A457**, 151 (2001).
- [19] Y.K. Semertzidis et al., *Nucl. Instrum. Meth.* **A503**, 458 (2003).
- [20] E. Efstathiadis et al, *Nucl. Instrum. Meth.* **A496**, 8 (2002).
- [21] OPERA, Electromagnetic Fields Analysis Program, Vector Fields Ltd., 24 Bankside, Oxford OX5 1JE, England.
- [22] R. Prigl et al., *Nucl. Instrum. and Meth.* **A374**, 118 (1996).
- [23] W.D. Phillips et al., *Metrologia* **13**, 179 (1979).
- [24] Superintendent of Documents, LORAN-C User's Handbook, U.S. Government Printing Office #050-012-00331-9, 1992.
- [25] S.A. Sedykh et al., *Nucl. Instrum. Meth.* **A455**, 346 (2000).
- [26] J. Ouyang, et al., *Nucl. Instrum. Meth.* **A374**, 215 (1996).
- [27] M. Sossong et al., *Traceback wire chamber system for the muon g-2 experiment*, submitted to *Nucl. Instrum. Meth.*, March 10, 2005.
- [28] Helmut Wiedemann, *Particle Accelerator Physics*, V1, Springer-Verlag, 1993.
- [29] F. Combley and E. Picasso, *Phys. Reports* **C14**, 1 (1974).
- [30] F.J.M. Farley, *Phys. Lett.* **42**, 66 (1972).
- [31] Jackson JD. *Classical Electrodynamics*, pp. 556-560, John Wiley & Sons Inc. (1975).
- [32] X. Fei, V.W. Hughes, and R. Prigl, *Nucl. Instrum. Meth.* **A394**, 349 (1997).
- [33] P.J. Mohr and B.H. Taylor, *Rev. Mod. Phys.* **77**, 1 (2005).
- [34] P.F. Winkler, D. Kleppner, T. Myint, and F.G. Walther, *Phys. Rev.* **A5**, 83 (1972).
- [35] W.E. Lamb Jr., *Phys. Rev.* **60**, 817 (1941).
- [36] H. Grotch and R.A. Hegstrom, *Phys. Rev. A* **4**, 59 (1971).
- [37] B.W. Petley et al., *Metrologia* **20**, 81 (1984).
- [38] V.W. Hughes, in *Physics Since Parity Symmetry Breaking*, ed. Fan Wang, World Scientific,

- Singapore, 508 (1999).
- [39] S.I. Redin *et al.*, Nucl. Instrum. Meth. **A473**, 260 (2001).
 - [40] Detector #2 is missing due to a hardware malfunction and station #20 is the traceback station.
 - [41] The $g - 2$ Collaboration, in preparation.
 - [42] M. Davier and W. Marciano, Ann. Rev. Nucl. Part. Sci. **54**, 115 (2004).
 - [43] M. Passera, J. Phys. **G31**, R75 (2005).
 - [44] T. Kinoshita and M. Nio, Phys. Rev. Lett. **90**, 021803 (2003); Phys. Rev. D **70**, 113001 (2004).
 - [45] W.A. Bardeen, R. Gastmans and B Lautrup, Nucl. Phys. **B46**, 319 (1972); R. Jackiw and S. Weinberg, Phys. Rev. D **5**, 157 (1972); I. Bars and M. Yoshimura, Phys. Rev. D **6**, 374 (1972); A. Czarnecki, B. Krause and W.J. Marciano, Phys. Rev. D **52**, R2619 (1995); S. Peris, M. Perrottet and E. de Rafael, Phys. Lett. **B355**, 523 (1995); A. Czarnecki, B. Krause and W.J. Marciano, Phys. Rev. Lett. **76**, 3267 (1996); G. Degrossi and G.F. Giudice, Phys. Rev. D **58**, 53007 (1998); Marc Knecht, Santiago Peris, Michel Perrottet, Eduardo De Rafael, JHEP **11**, 003 (2002); A.Czarnecki, W.J. Marciano, A. Vainshtein, Phys. Rev. D **67**, 073006 (2003).
 - [46] M. Davier, S. Eidelman, A. Höcker, and Z. Zhang, Eur. Phys. J. **C31**, 503 (2003).
 - [47] R.R. Akhmetshin, et al, CMD2 collaboration, Phys. Lett. **B578**, 285 (2004).
 - [48] A. Aloisio, et al., KLOE Collaboration, Phys. Lett. **B606**, 12 (2005).
 - [49] M. Davier, S. Eidelman, A. Höcker, and Z. Zhang, Eur. Phys. J. **C27**, 497 (2003).
 - [50] R. Alemany, M. Davier and A. Höcker, Eur. Phys. J. **C2**, 123 (1998).
 - [51] M. Davier and A. Höcker, Phys. Lett. **B435**, 427 (1998).
 - [52] K. Hagiwara, A.D. Martin, Daisuke Nomura, and T. Teubner, Phys. Lett. **B557**, 69 (2003); Phys. Rev. D **69**, 093003 (2004).
 - [53] Bernd Krause, Phys. Lett. **B390**, 392 (1997).
 - [54] Johan Bijnens, Elisabetta Pallante and Joaquim Prades, Phys. Rev. Lett. **75**, 1447 (1995); Phys. Rev. Lett. **75**, 3781 (1995); Nucl. Phys. **B474**, 379 (1996); Nucl. Phys. **B626**, 410 (2002).
 - [55] M. Hayakawa and T. Kinoshita Phys. Rev. D **57**, 465 (1998); and KEK-TH-793 (2001).
 - [56] Marc Knecht, Andreas Nyffeler, Phys. Rev. D **65**, 073034 (2002).
 - [57] M. Knecht, A. Nyffeler, M. Perrottet, E. deRafael, Phys. Rev. Lett. **88**, 071802 (2002).
 - [58] I. Blokland, A. Czarnecki and K. Melnikov Phys. Rev. Lett. **88**, 071803 (2002).
 - [59] K. Melnikov and A. Vainshtein, Phys. Rev. D **70**, 113006 (2004).

- [60] Andrzej Czarnecki and William J. Marciano, *Phys. Rev. D* **64**, 013014 (2001).
- [61] T. Blum, *Phys. Rev. Lett.* **91**, 052001 (2003).
- [62] New (g-2) Collaboration: R.M. Carey, et al., *A (g-2) Experiment to 0.2 ppm Precision*, BNL P969, (2004).

Muon g-2 Experiment at Fermilab



During the summer of 2013, the Muon g-2 team successfully moved the 50-foot-wide particle storage ring 3200 miles by land and sea from New York to Illinois.

The main goal is to test the Standard Model's predictions of this value by measuring the precession rate experimentally to a **precision of 0.14 parts per million**.